

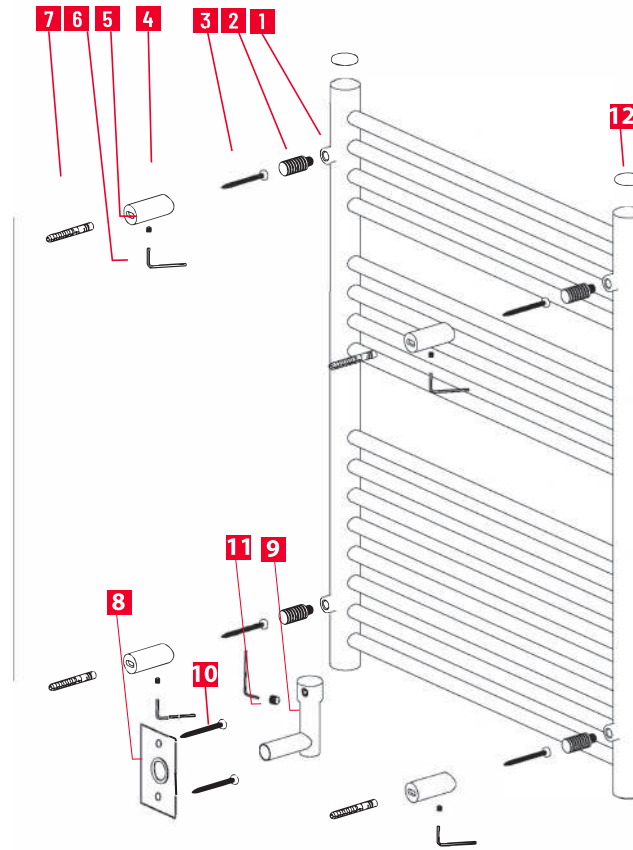













Towel
Warmers

SEATTLE Installation Guide







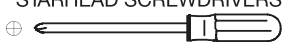
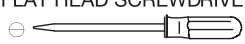

Accessories

- | | | | |
|---|--|---|--|
| 1  Solid Fixing Lug 4 pcs | 4  Wall Support 4 pcs | 7  Set Screws 4 pcs | 10  Set Screws 1 piece |
| 2  Wall Support Core 4 pcs | 5  Grub Screw 4 pcs | 8  Plate 1 piece | 10  Wall Plate Screws 2 pcs |
| 3  Screw 4 pcs | 6  Allen Key 2 pcs | 9  Plate 1 piece | 12  Plastic Cap 2 pcs |

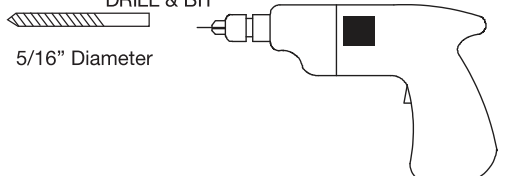
Required Tools

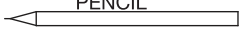
- | | | | |
|---|---|---|--|
| <p>STARHEAD SCREWDRIVERS</p>  | <p>FLAT HEAD SCREWDRIVERS</p>  | <p>MEASURING TAPE</p>  | <p>DRILL & BIT</p> <p>5/16" Diameter</p>  |
| <p>LEVEL</p>  | <p>PENCIL</p>  | | |

PRODUCT INSTALLATION

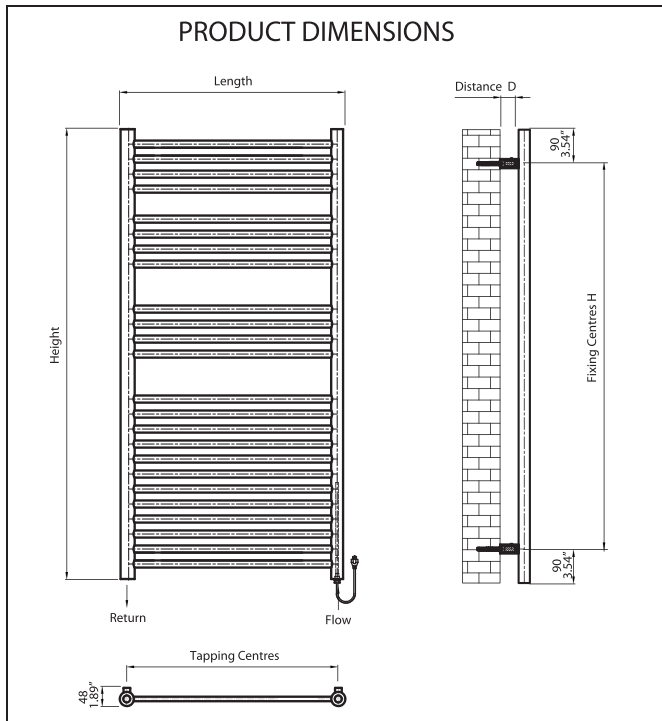

- All the dimensions are shown in millimetres/inch
- Horizontal Tube dia 19mm
- Vertical Tube dia 38mm
- Bracket length - 27mm
- Rated 100,150,300 or 400W dependent on model
- Suitable for 120V supply, three wire connection
- The electric towel rails conform to: the requirements of UL499 CSA C22.2 No.60335-1 and E60335-2-43

Please Note:

- All towel warmers contain a factory - filled glycol mixture
- Not suitable for use on domestic hot water system
- Before starting, ensure situation and orientation

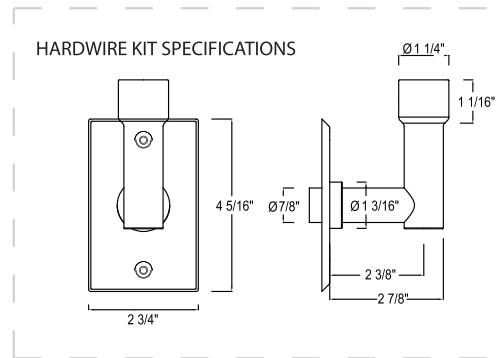

| Vernon | Weight (KG) | Tapping Centres (mm)/inch | Fixing Centres (H) (mm)/inch | Distance (D) (mm)/inch | Height (mm)/inch | Length (mm)/inch |
|-------------|-------------|---------------------------|------------------------------|------------------------|------------------|------------------|
| SEA-0800600 | 12.7 | 562/22.12" | 620/24.41" | 60/2.36" | 800/31.5" | 600/19.68" |
| SEA-1200600 | 18.9 | 562/22.12" | 1020/40.16" | 60/2.36" | 1200/47.24" | 600/19.68" |

Step 1

Use the wall support core (2) to fix the solid fixing lug (1) to the threaded metal pad on the vertical bar on the back of the towel warmer.

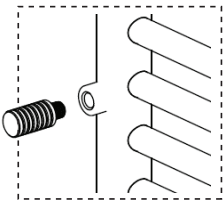

Step 2

Use a tape to measure the distance between the center points of each wall bracket tube; record the distances between points AB, AC, CD, and BD. Mounting point C will determine electrical box location. See Electrical Assembly in following instructions.

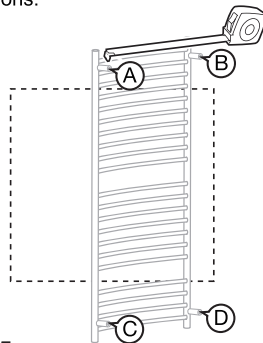

Step 3

Drill A, B, C, and D holes with an appropriately sized bit.

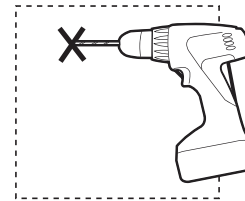

Step 4

Insert wall screw (3) through wall support (4) then screw into wall plug (7) .



Step 5

Install the tube onto the wall support (4)

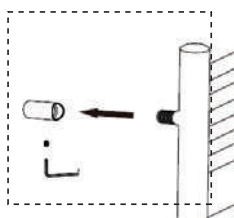

Step 6

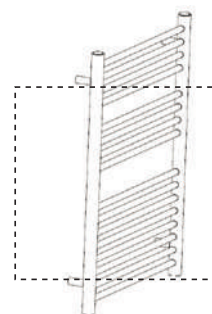

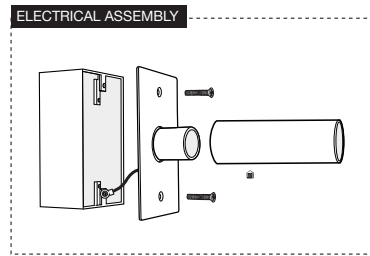

NOTE:

The power lead must be connected to a socket or connection block, which must be at least 25CM from the floor.

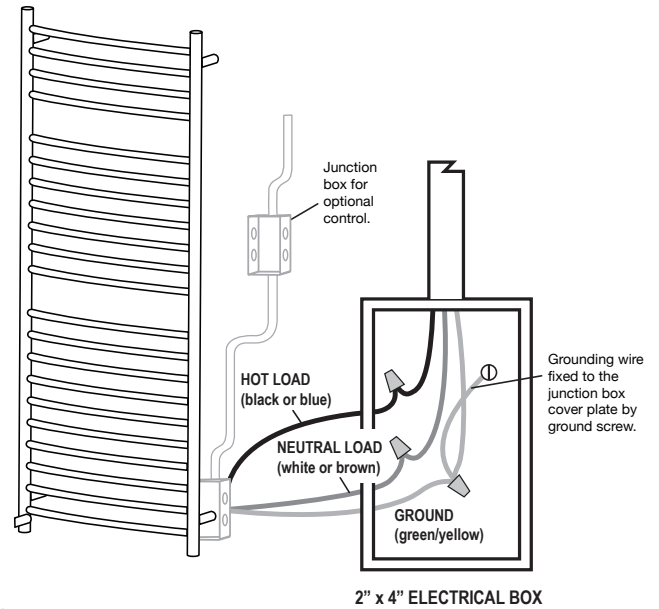
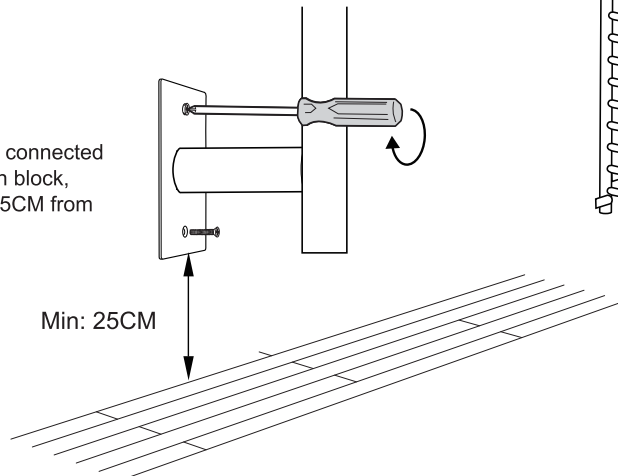

Step 7

Without Hardware Kit

Guide the electrical cord through the plastic cap (b) and use the mounting screw (e) to tighten the electrical connection mounting tube to the vertical bar.

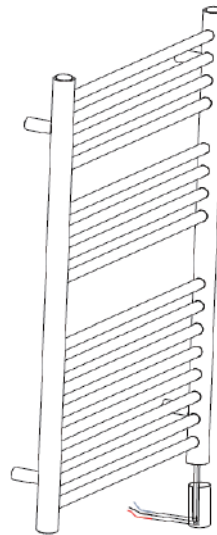

Step 8

With Hardware Kit

- Create a hole in the wall to let the Hard Wire Leg go through (approx. 2 in. x 3 3/4 in.).
- The leg will be covered by Plate so the hole should be large enough to allow space for electrical connection and leg to go through but not too large so that the plate can cover it fully.
- Guide the electrical cord through the electrical connection mounting tube (9) and use the mounting screw (10) to tighten the electrical connection mounting tube to the vertical bar.

