

**FR** Garniture pour mitigeur thermostatique THG avec robinet d'arrêt ref. 5300AE avec boîtier d'encastrement

**EN** Trim for THG thermostat with stop valve, -ref. 5300AE with box for rough parts

**CN** 恒温龙头THG带截止阀ref.5300AE带冲洗安装盒

**DE** Garnitur für Unterputz-Thermostat THG, Ref. 5300AE 3/4", mit 2 Absperrventilen

**ES** Parte exterior del termostático con una llave de paso integrada (para ref 5300AE con caja de empujar)

**IT** Guarnizione per valvola miscelatrice termostatica THG con rubinetto di arresto rif.5300AE con scatola da incasso

**NL** Pakking voor thermostatische mengkraan THG met afsluitkraan ref.5300AE met inbouwbehuizing

**RU** Гарнитура для термостатического смесителя THG с запорным краном арт.5300AE с корпусом для встройки

**AR** تجهيزات إضافية للخلاط المنظم للحرارة THG مع صنوبر الغلق الرمز المرجعي 5300AE مرفق بصندوق الدمج

### Outillage (Non-fourni)

Tools (Not provided)

工具 (自备)

Werkzeuge (Nicht mitgeliefert)

Herramientas (no suministradas)

Utensili (non forniti)

Gereedschap (Niet meegeleverd)

инструменты (Не обеспечен)

(الأدوات غير مرفقة)

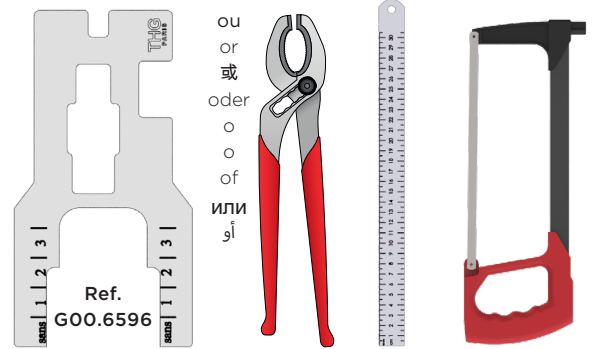

Assurez vous d'avoir purgé les canalisations et vérifié l'étalonnage de la cartouche

确保已清空管道并检查滤芯的校准

Asegúrese de que ha limpiado los conductos y verificado la calibración del cartucho

Assicurarsi di aver spurgato le condutture e controllato la calibrazione della cartuccia

Make sure you have purged the water pipes, and checked the calibration of the cartridge

Stellen Sie sicher, dass Sie die Kanäle gespült und die Kalibrierung der Kartusche überprüft haben

Zorg ervoor dat u de leidingen hebt ontluicht en de kalibratie van de cartouche hebt gecontroleerd

Убедитесь, что вы прочистили трубопроводную сеть и проверили калибровку картриджа

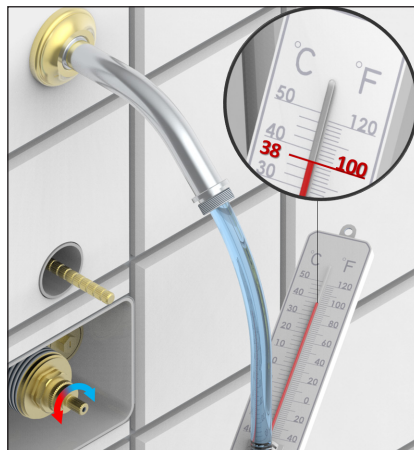

ترياعمر نم ققحتو تاونق لا ري هطت نم دلأت  
شوطرخ لا

### Outillage (fourni)

Tools (included)

工具

Werkzeug (mitgeliefert)

Herramientas (proporcionadas)

Attrezzatura (fornita)

Bevestiging inclusief

непредоставляемые инструменты



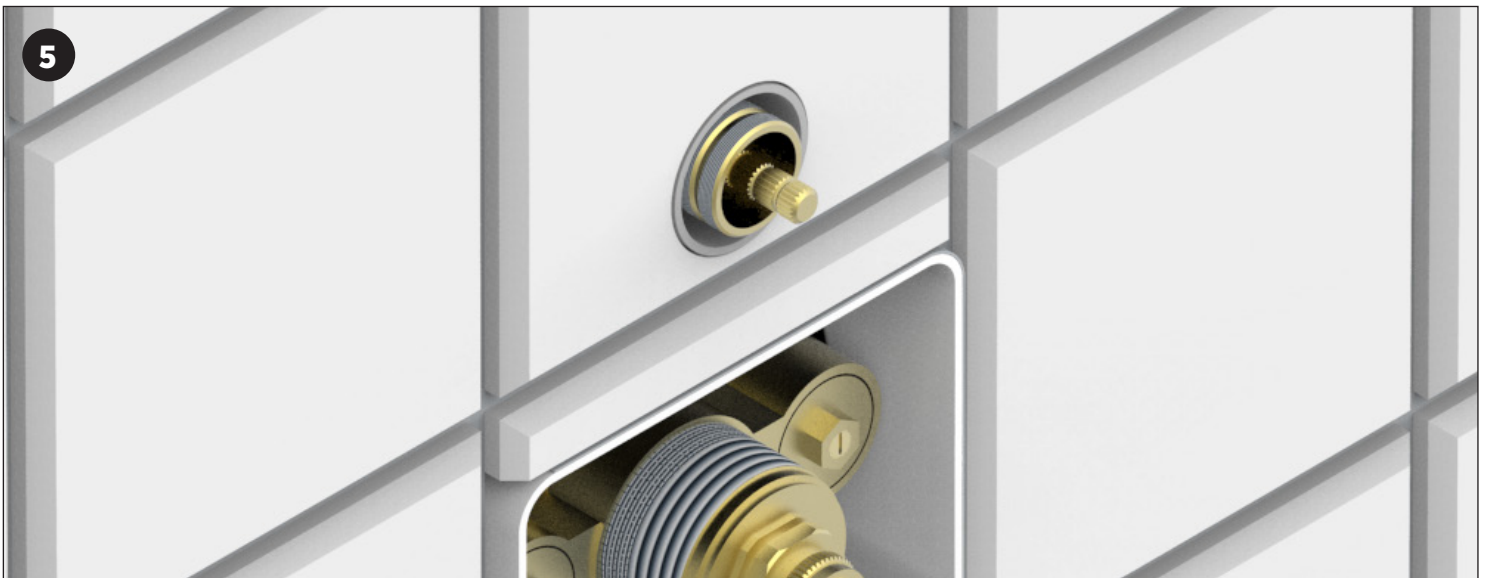
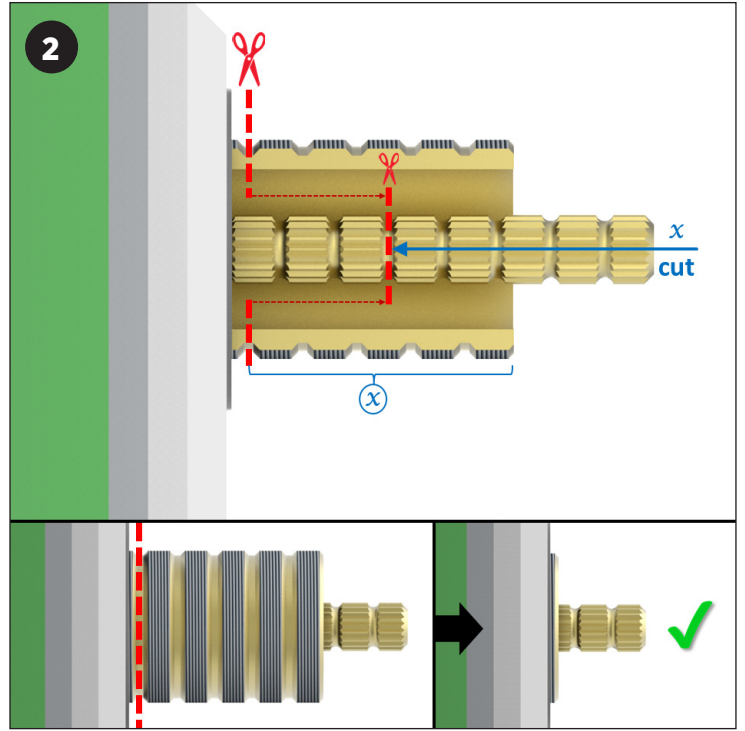
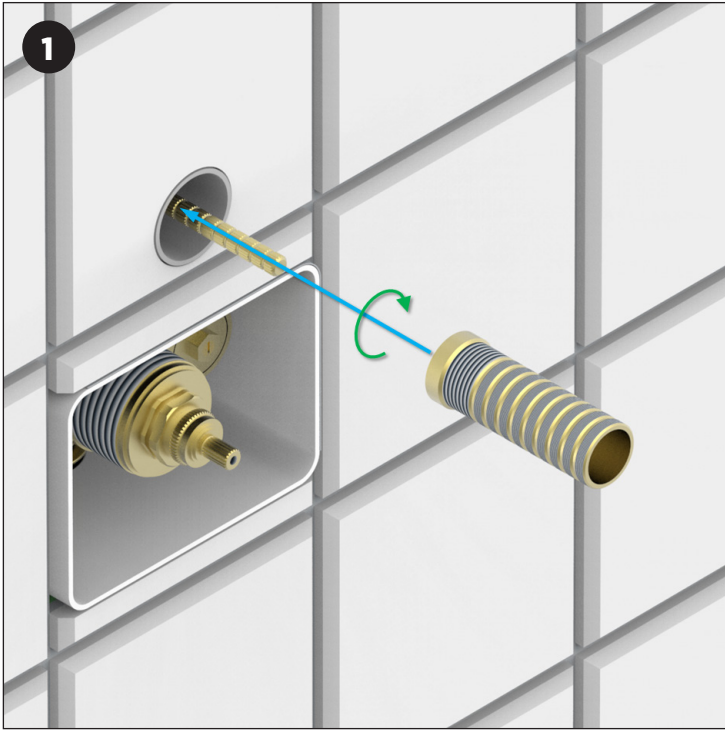

6 a

Ref.  
G00.6596

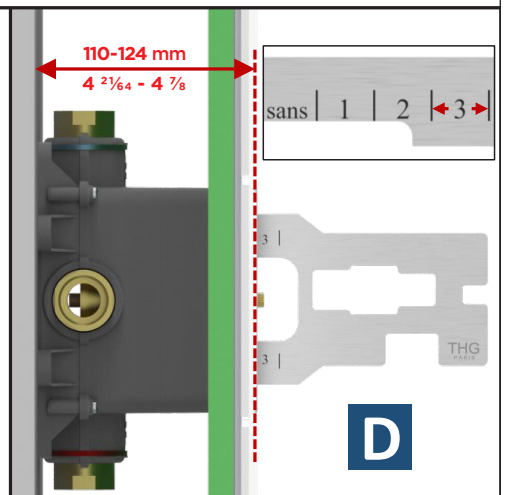
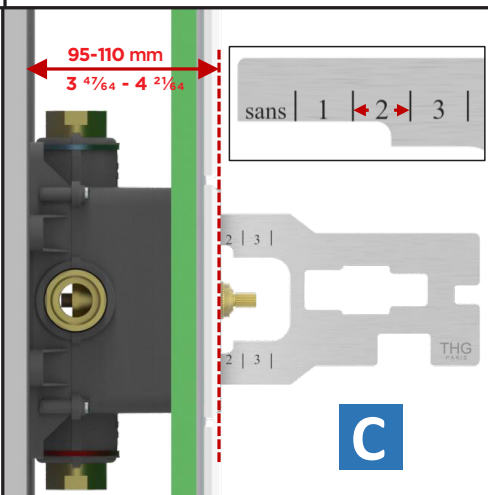
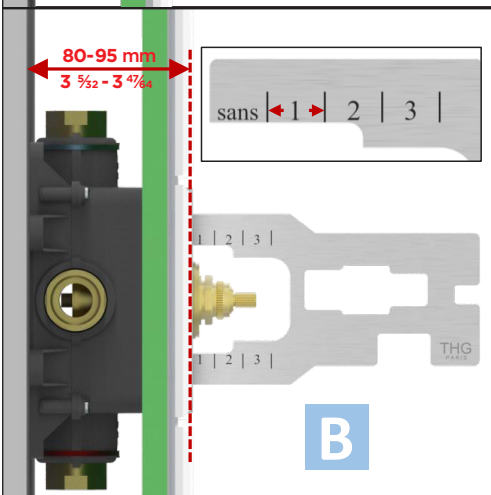
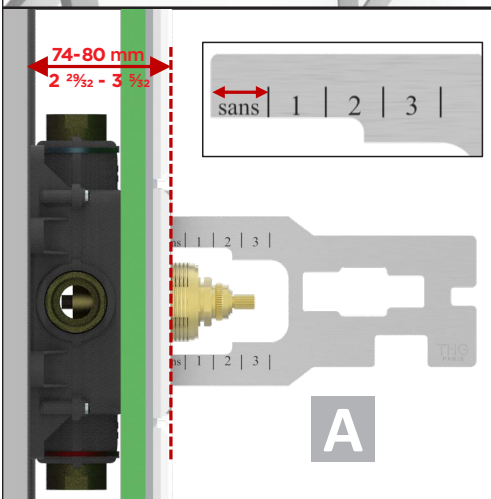
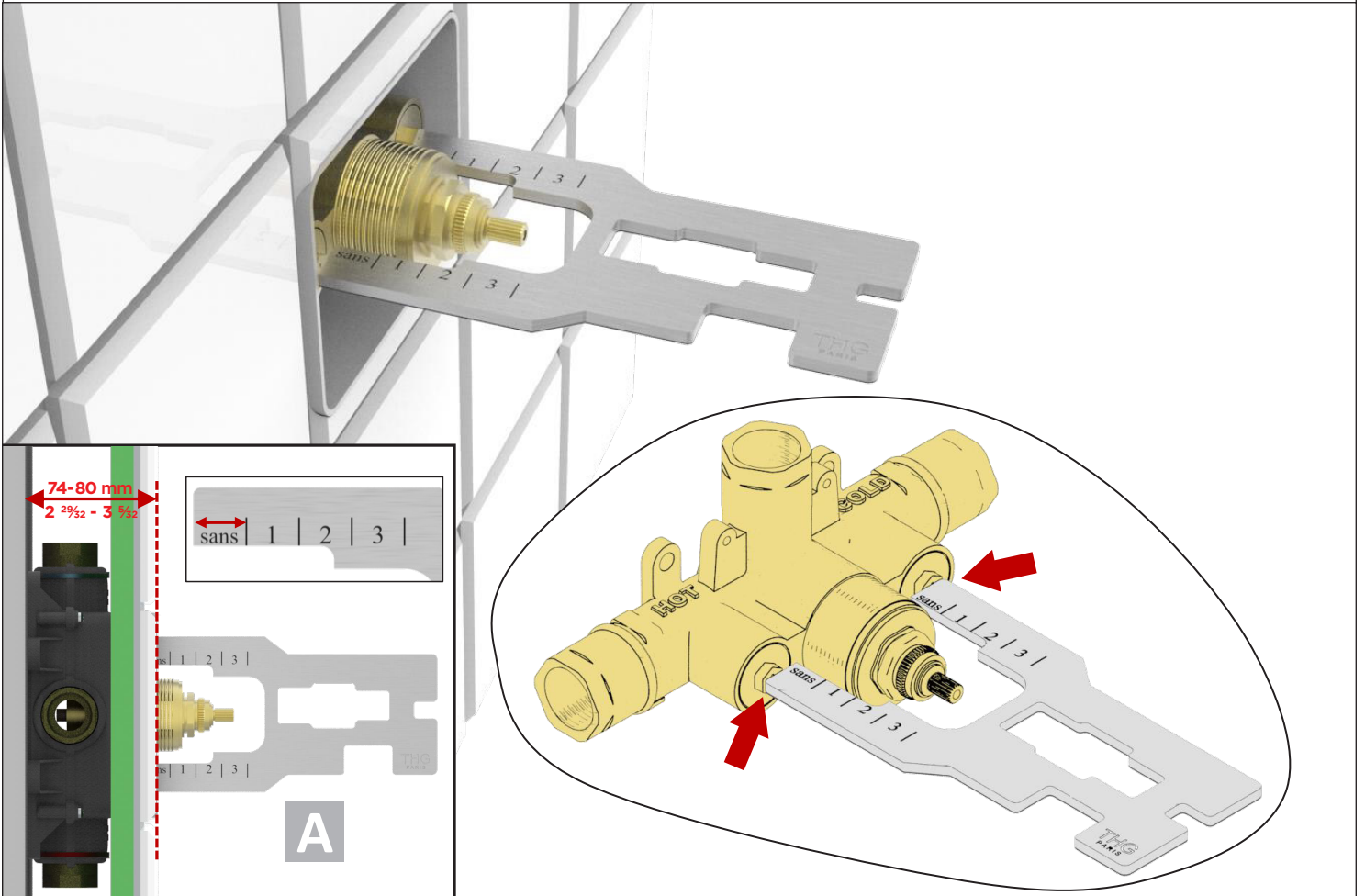
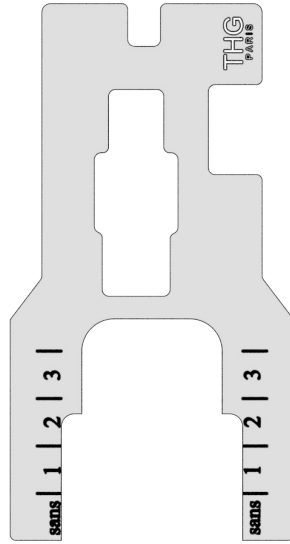

6  
b

ou  
or  
或  
oder  
o  
o  
of  
или  
أو

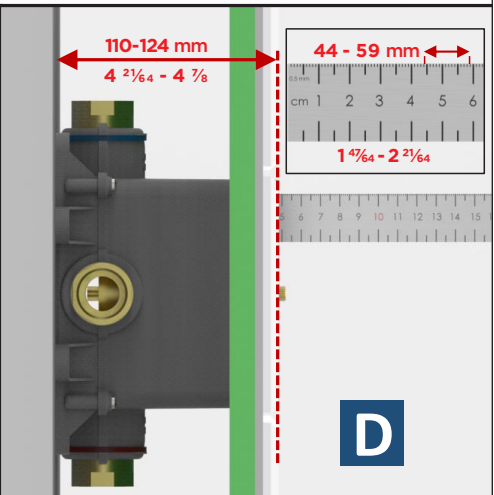
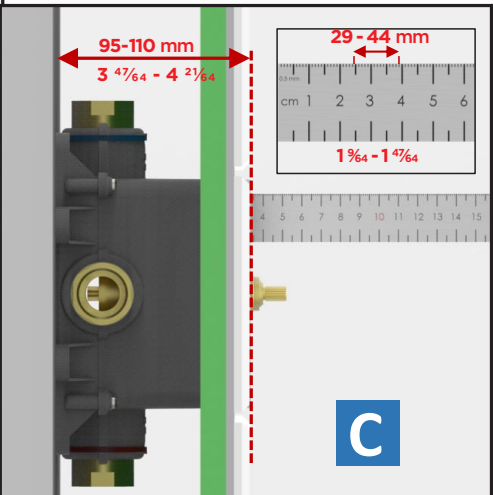
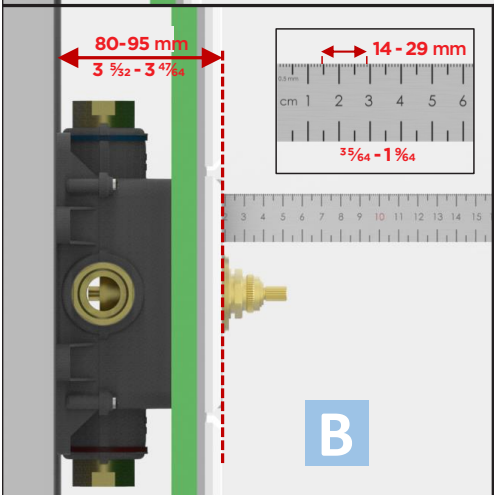
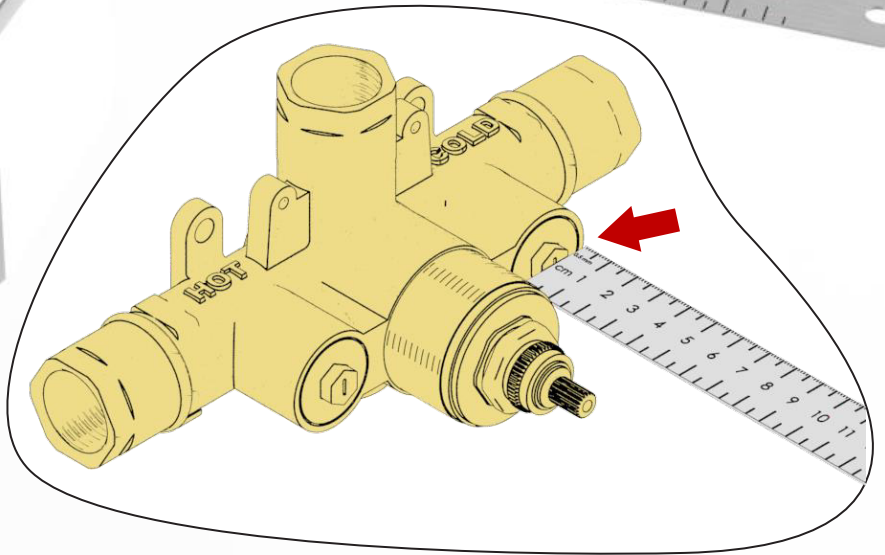
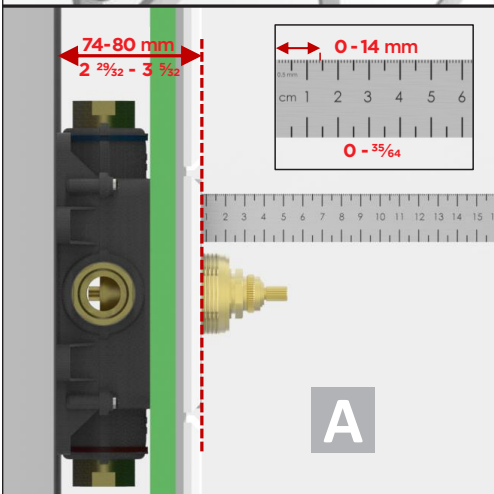
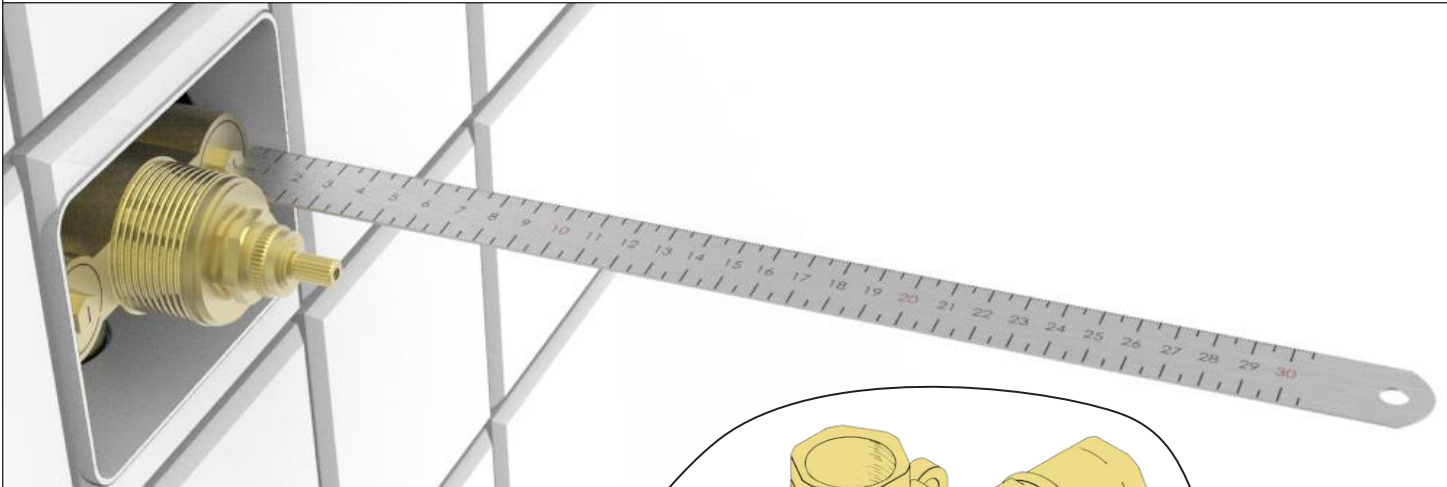

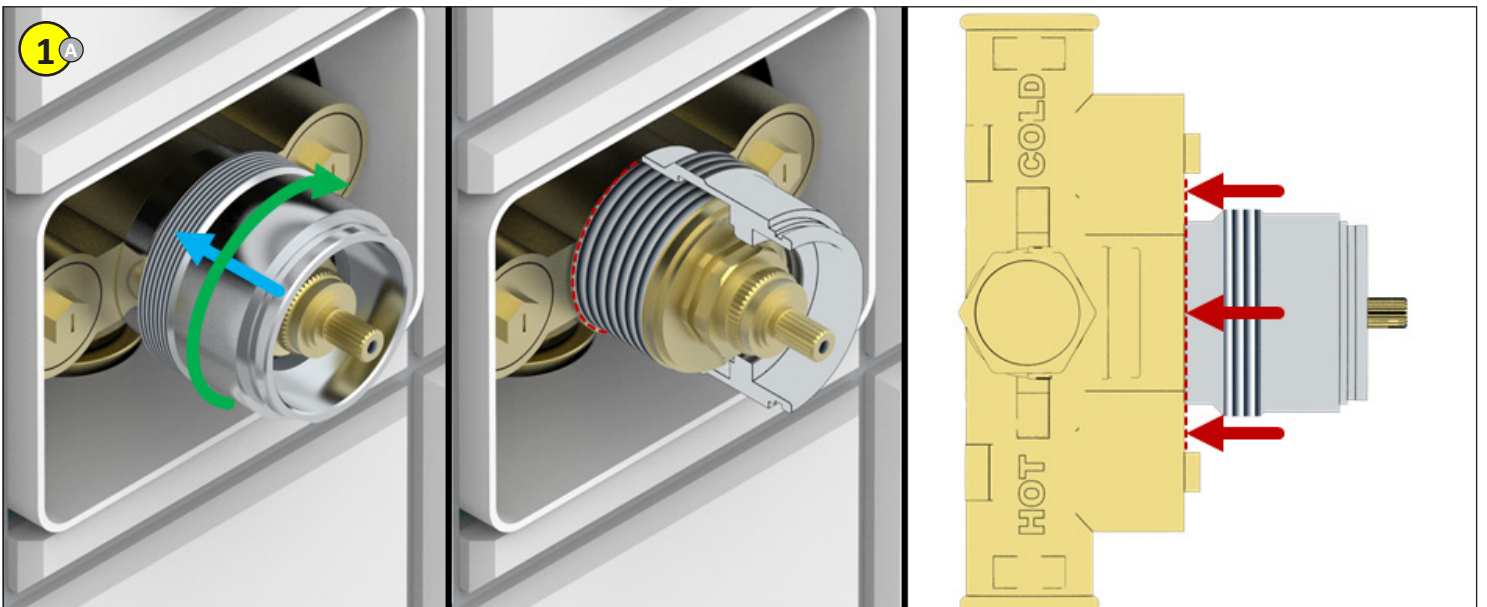
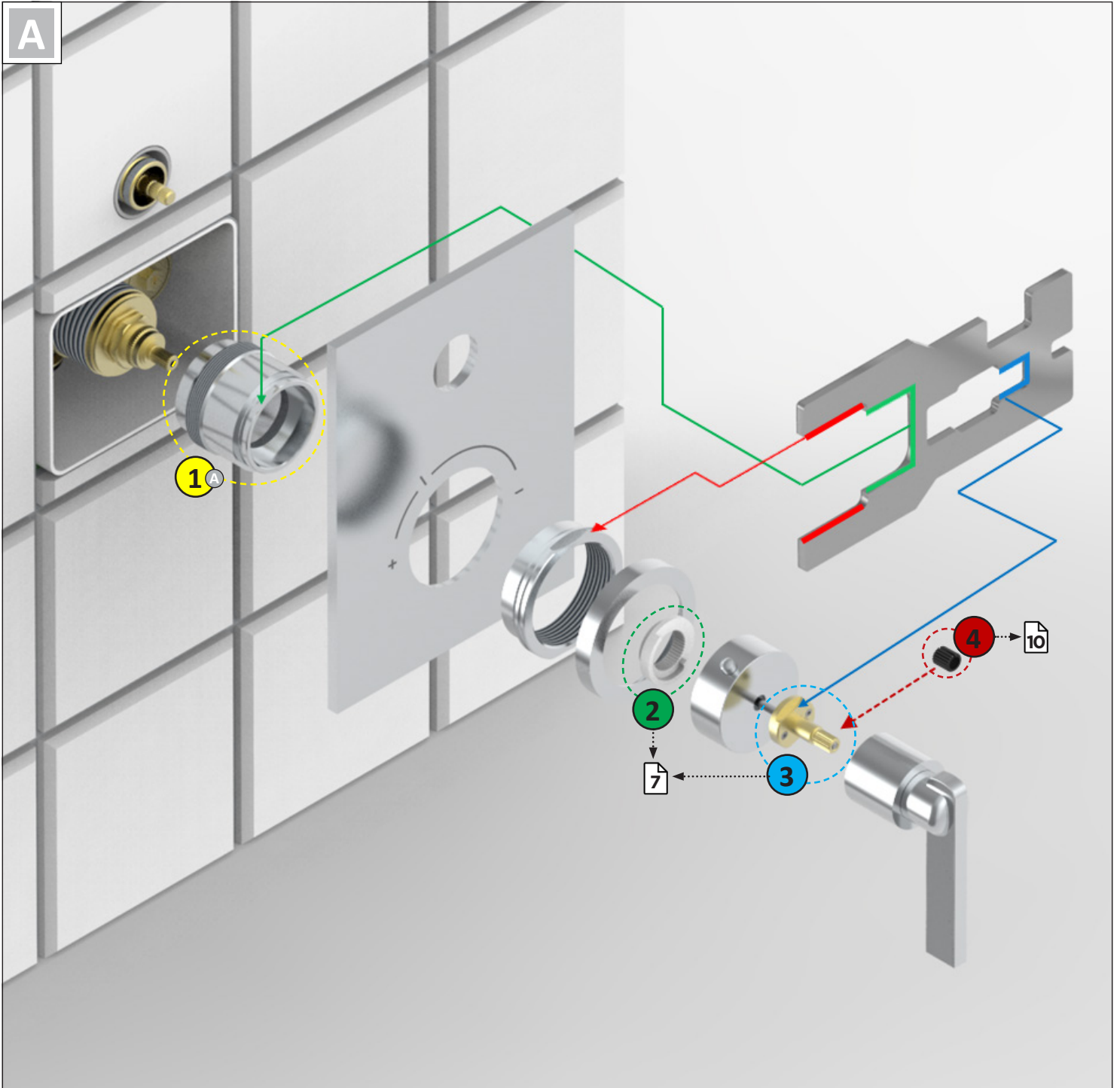

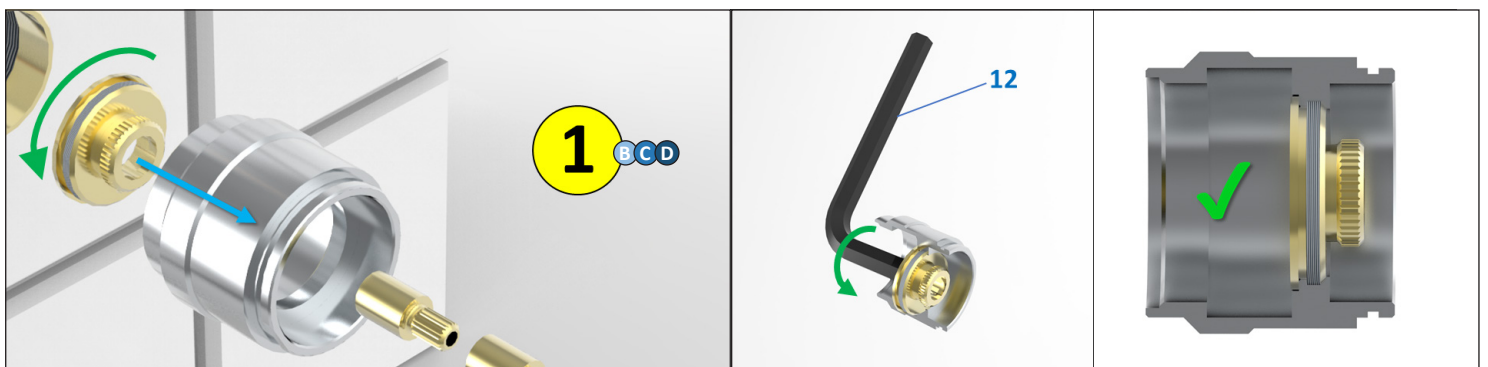
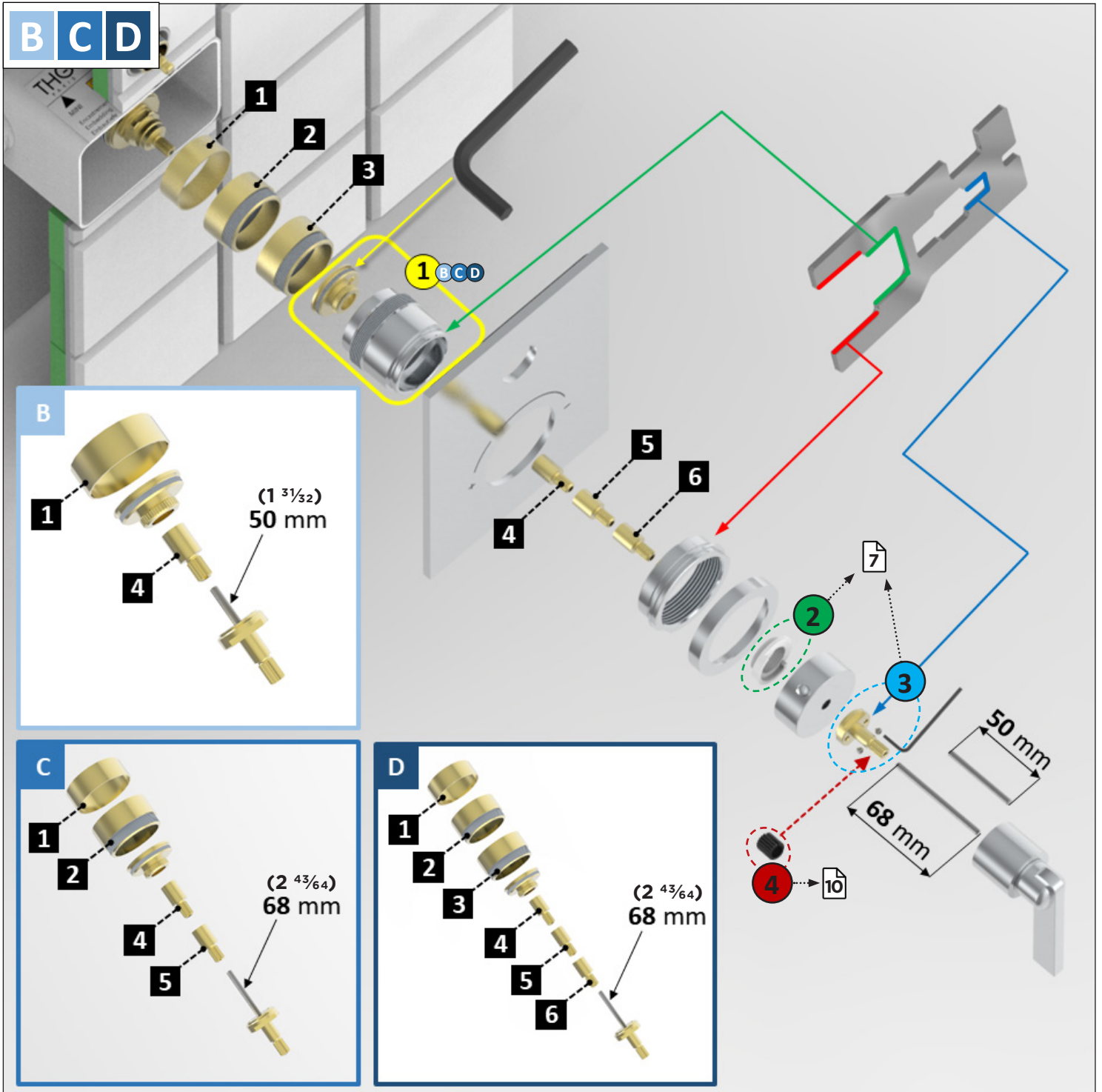

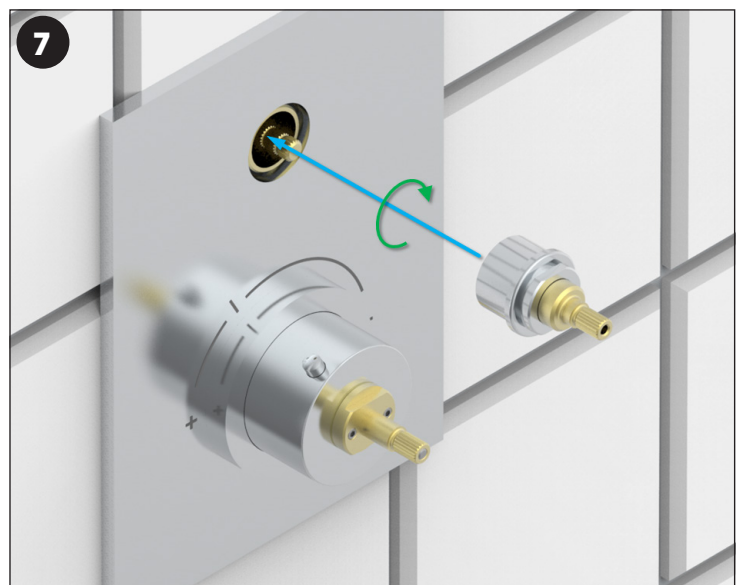
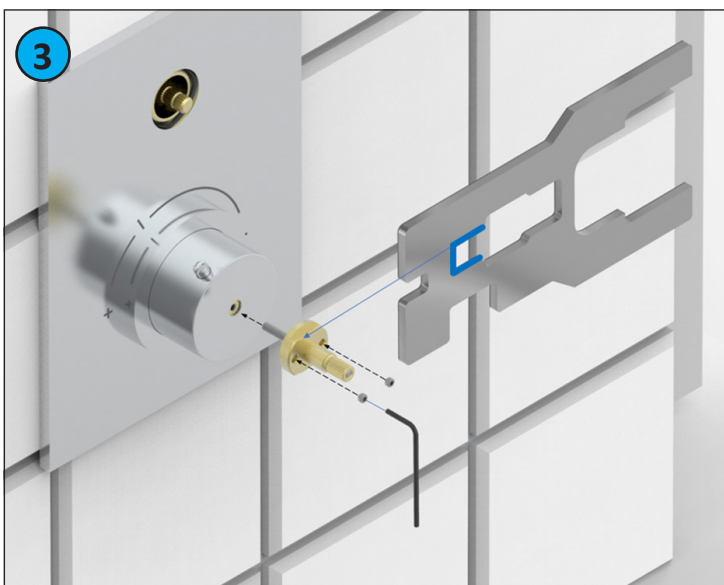
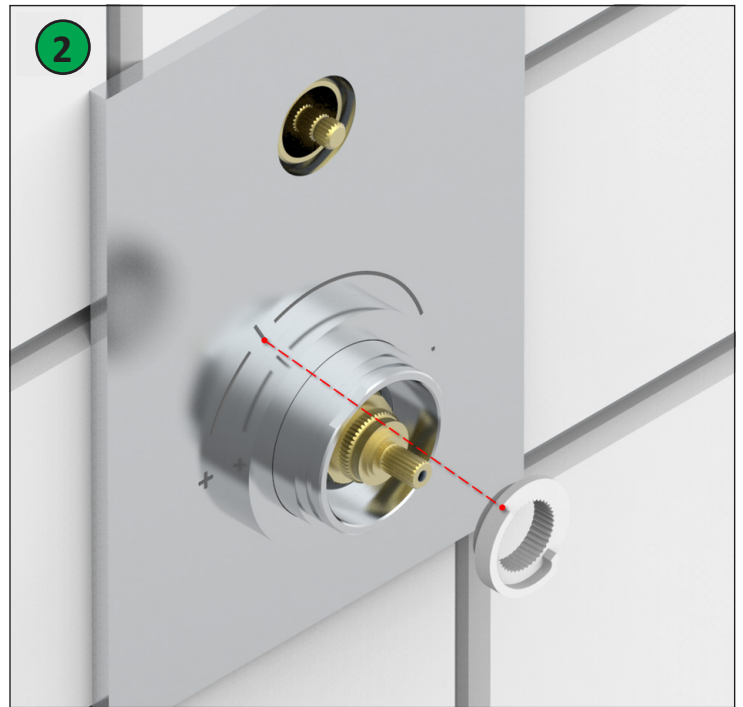
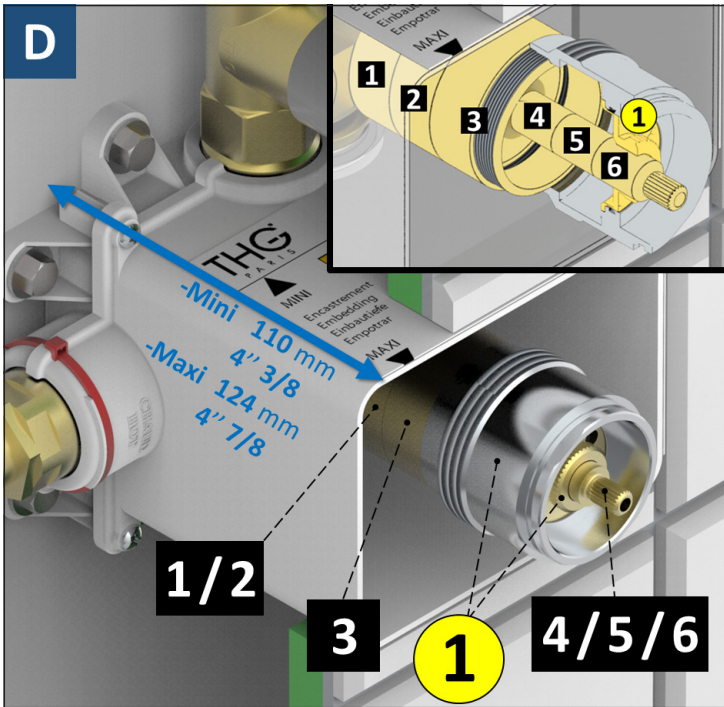
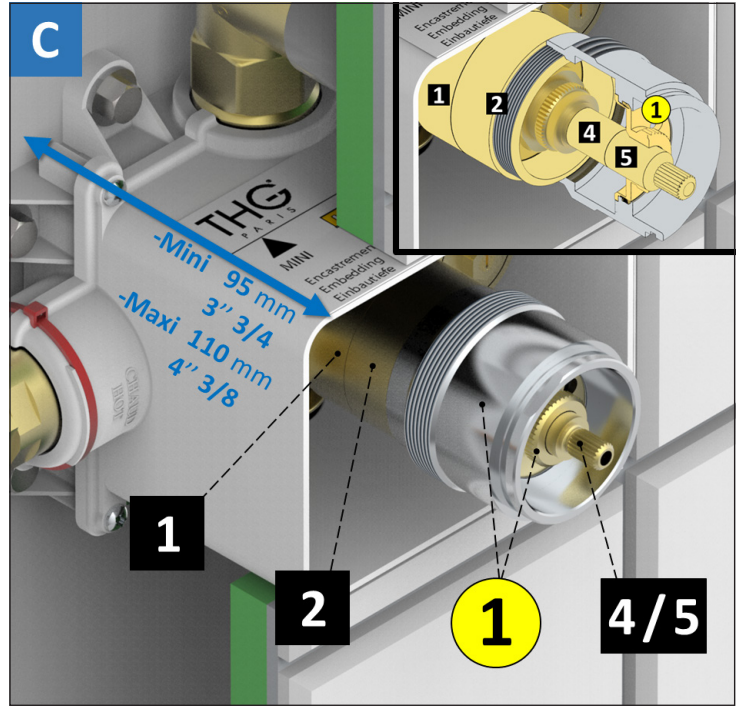
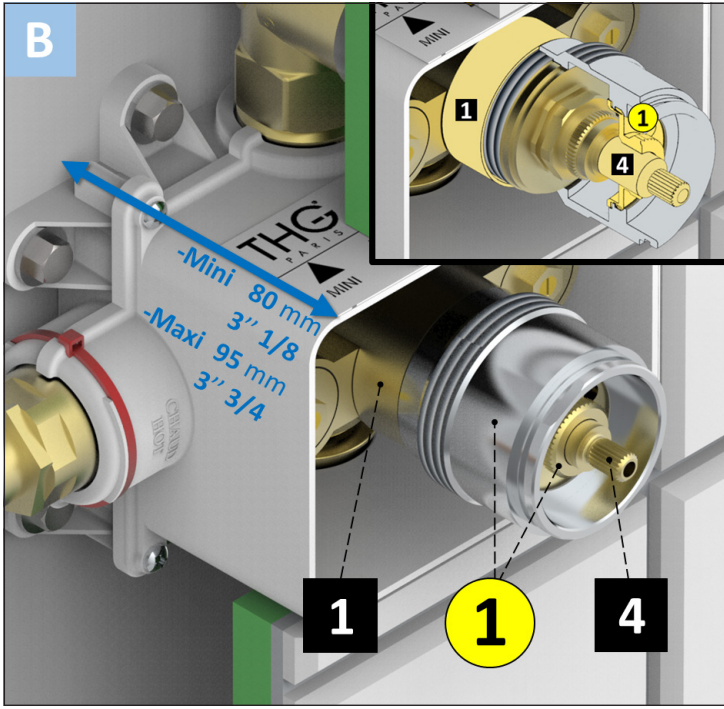

Montage des croisillons / manettes

Handle / lever assembly

装配十字接头 / 手柄

Montage von Traversen / Armaturen

Montaje de separadores/palancas

Montaggio dei transetti/manopole

Montage kraanknoppen/handgreep

Монтаж крестообразных рукояток / рычагов

تركيب ضوابط صليبية/مقابض

8

### 4 cas possibles

4 possible cases

4 种可能的案例

4 mögliche Fälle

4 casos posibles

4 casi possibili

4 gevallen mogelijk

4 варианта возможны

4 حالات ممكنة

1

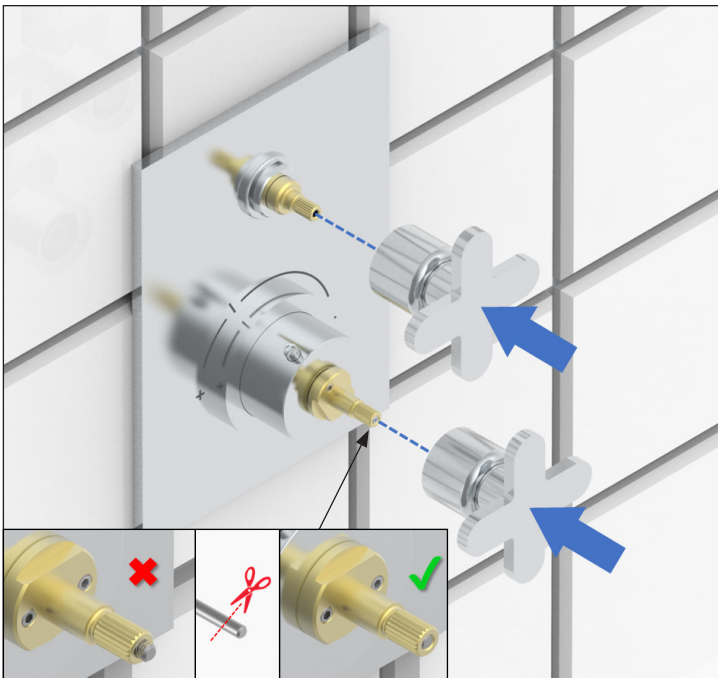

2

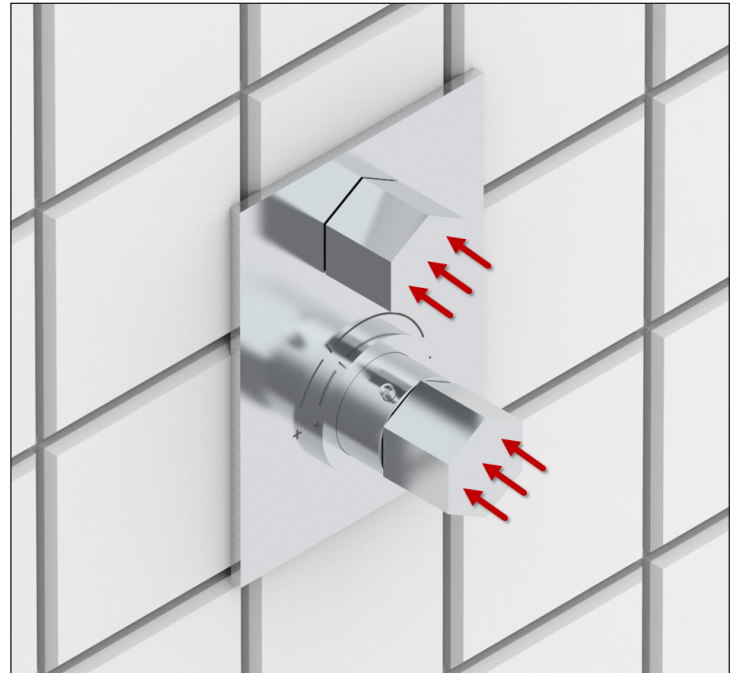
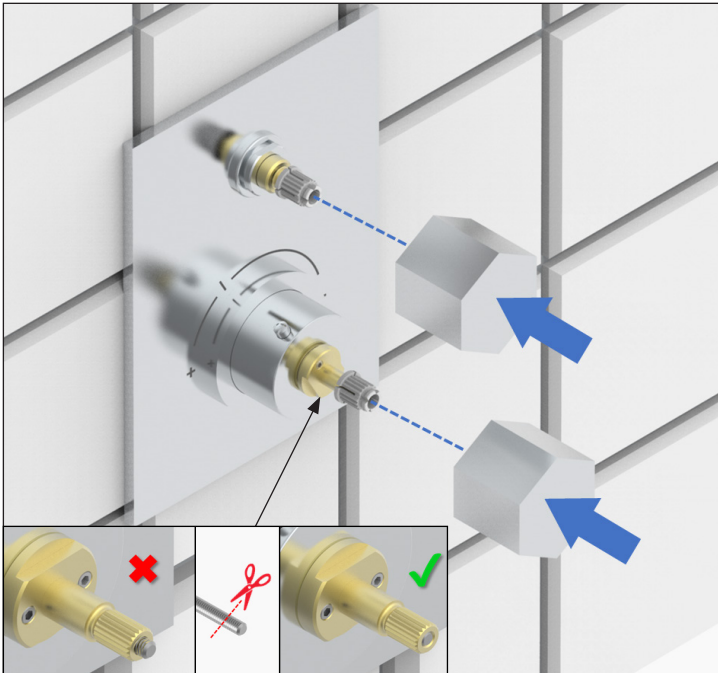



3

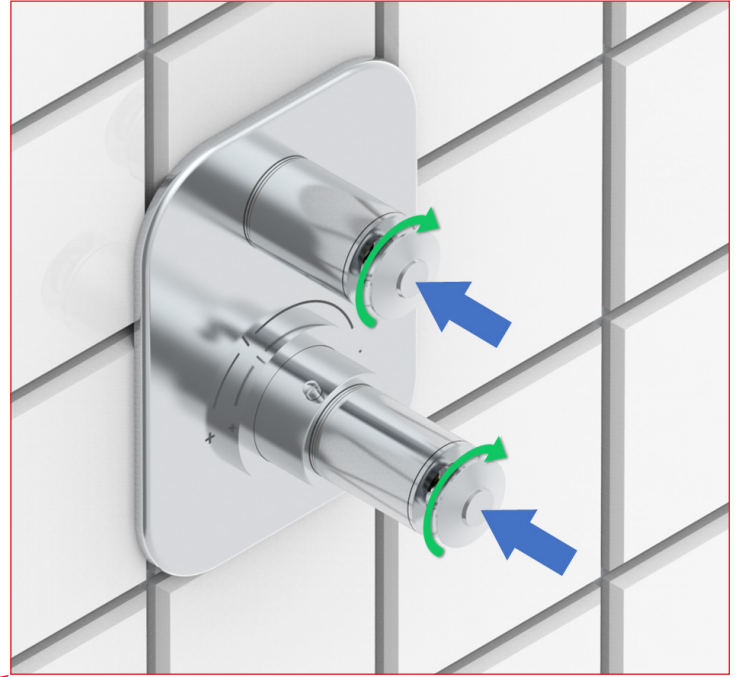
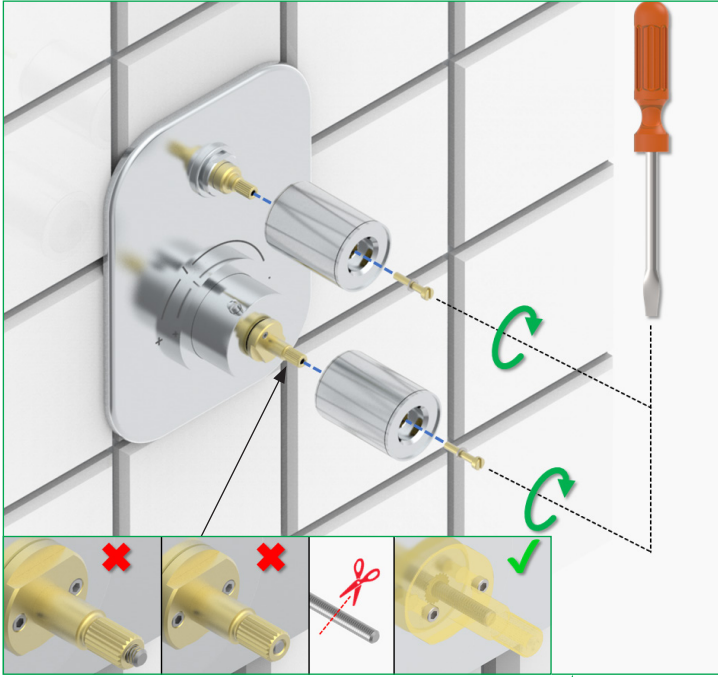

4

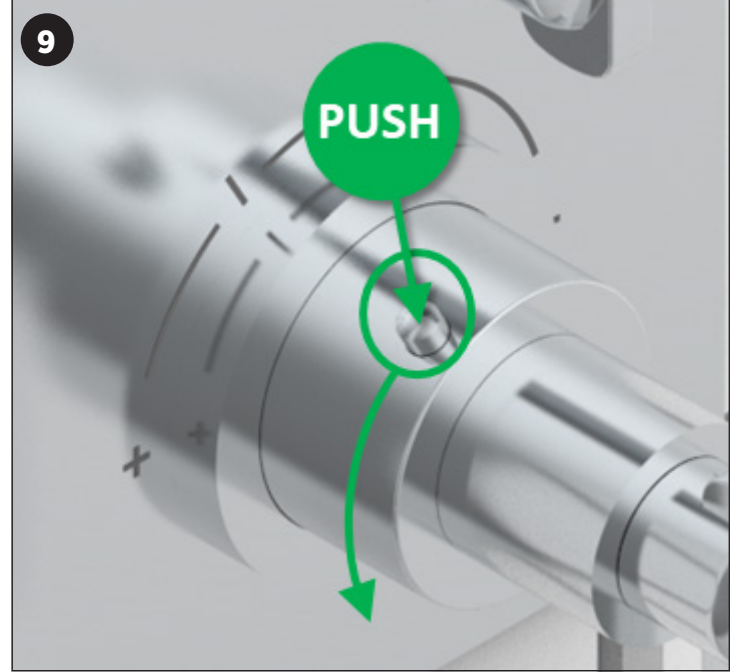
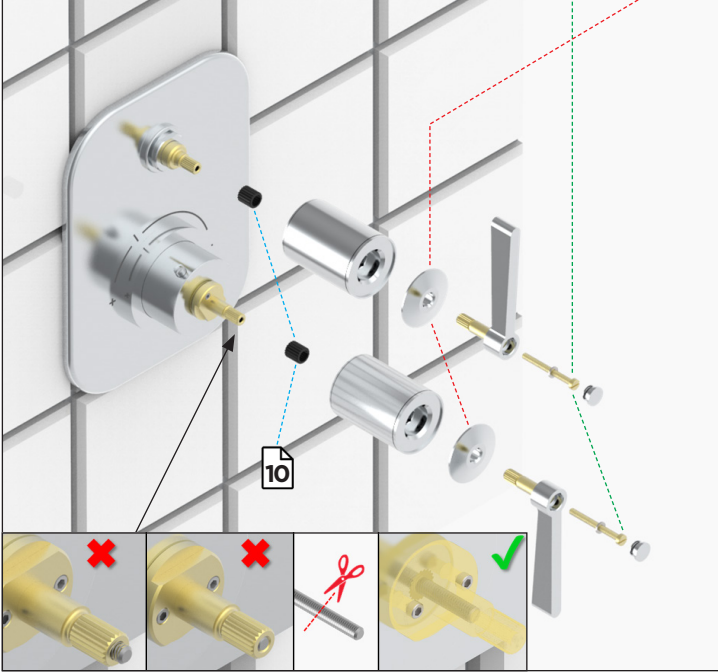

Réglage de température / Temperature adjustment / 温度校准 / Temperatureinstellung / Ajuste de temperatura / Regolazione della temperatura / Instellen van temperatuur / Регулировка температуры / ضبط الحرارة

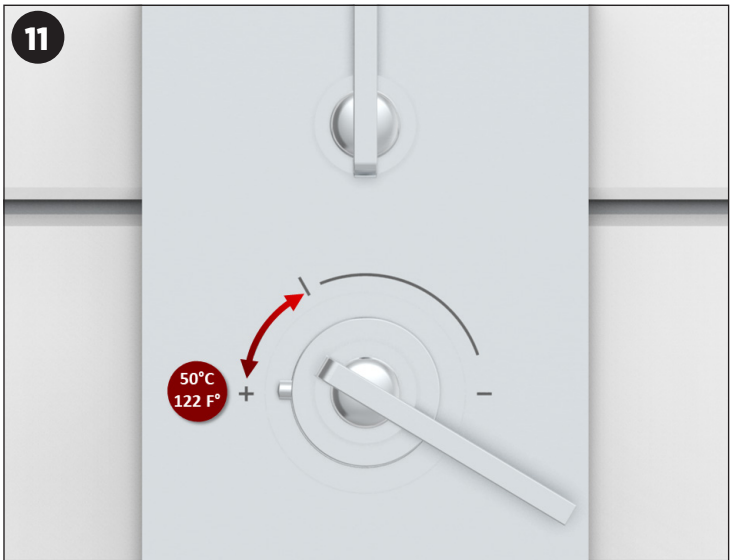
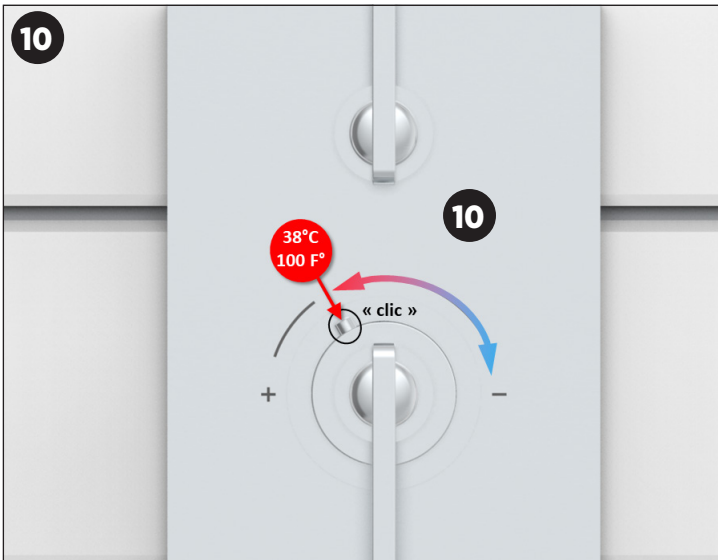

# Insert plastique strié

Notice d'installation / Installation instructions / 安装说明 / Installationsanleitung / Instrucciones de instalación / Istruzioni per l'installazione / Installatie handleiding / Инструкции по установке / إرشادات التركيب

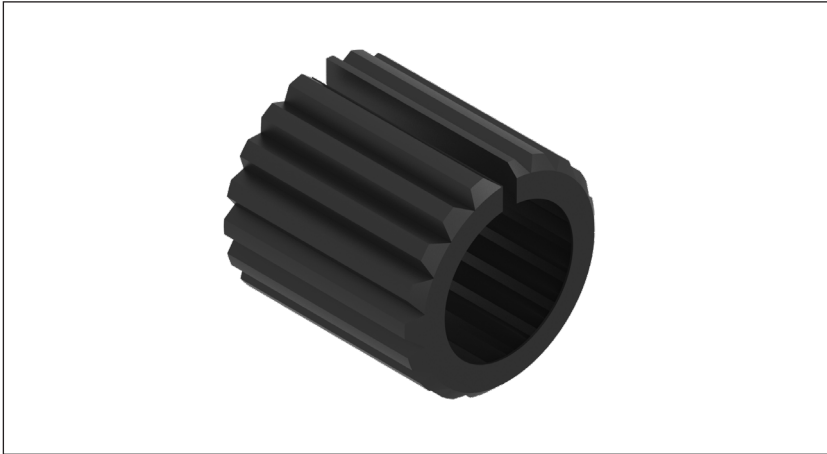

- FR** Insert plastique strié
- EN** Grooved plastic insert
- CN** 条纹塑料插件
- DE** Geriffelter Kunststoffeinsatz
- ES** Inserto plástico estriado
- IT** Inserto in plastica striata
- NL** Gegroefde kunststof inleg
- RU** Пластиковая рубчатая прокладка

ملحق بلاستيكي مُحزَّر **AR**

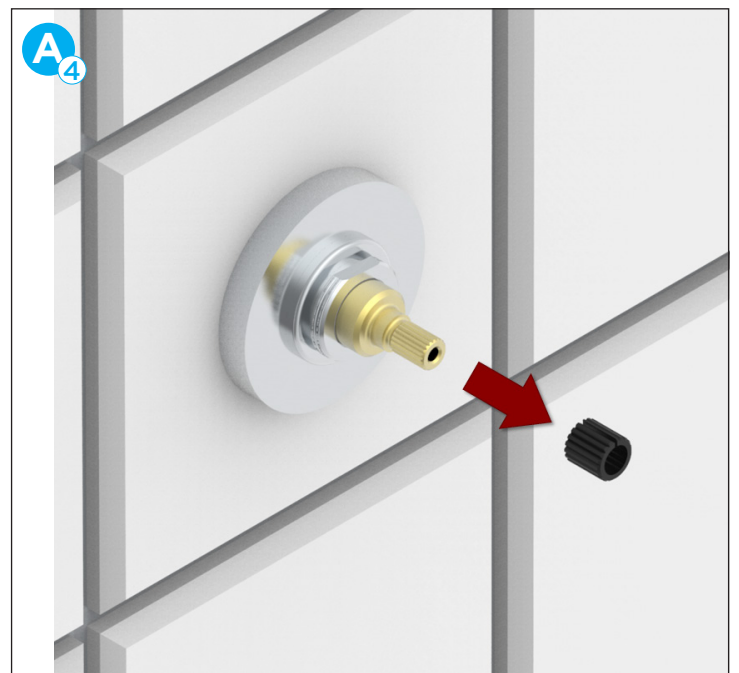
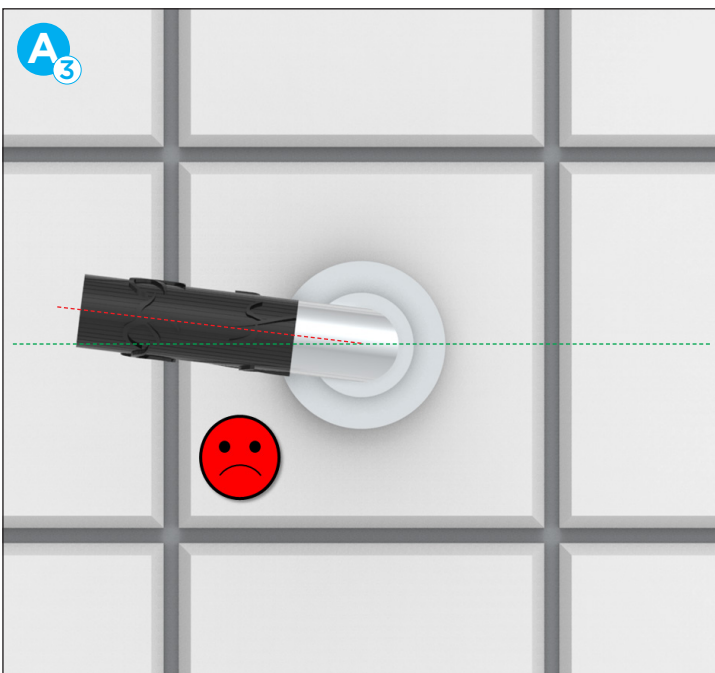
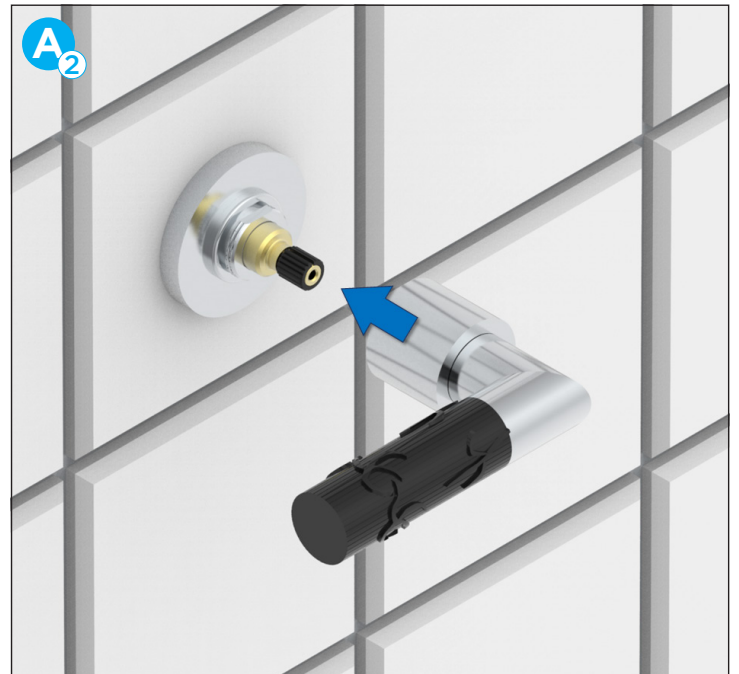
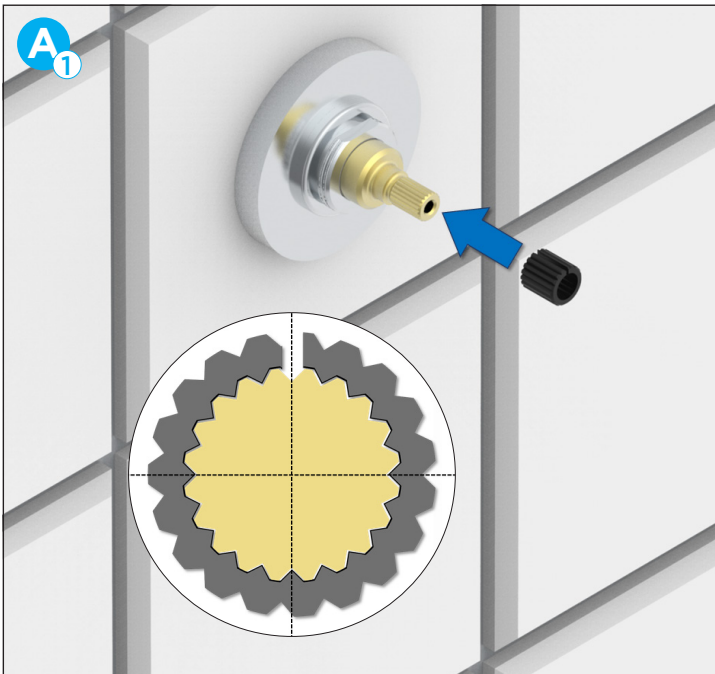

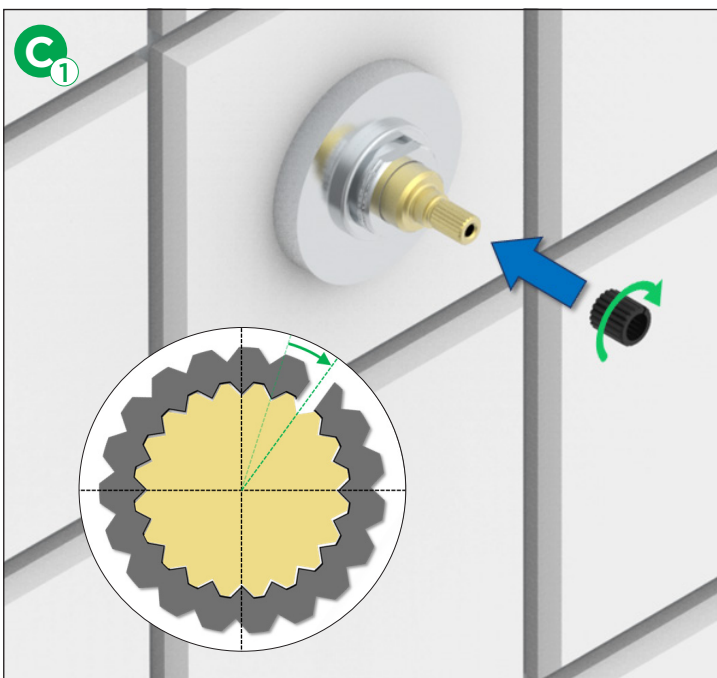
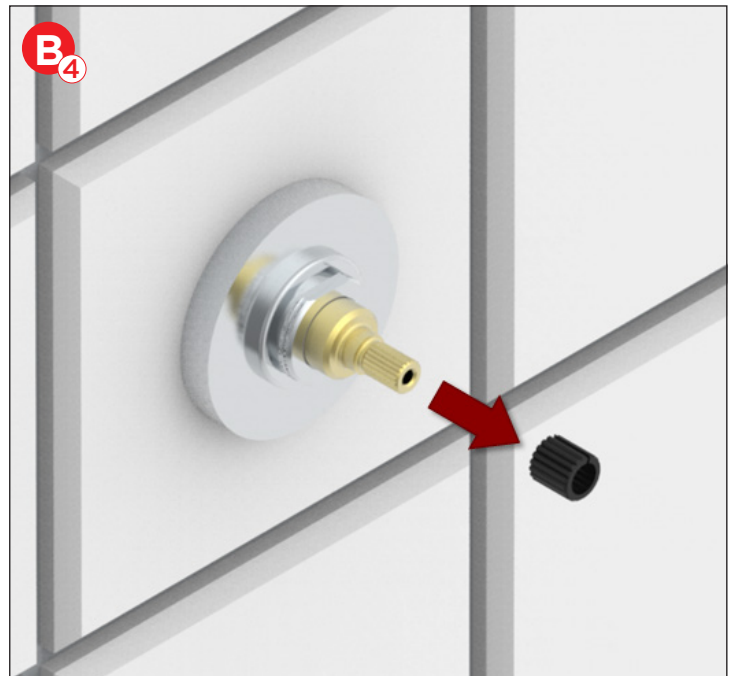
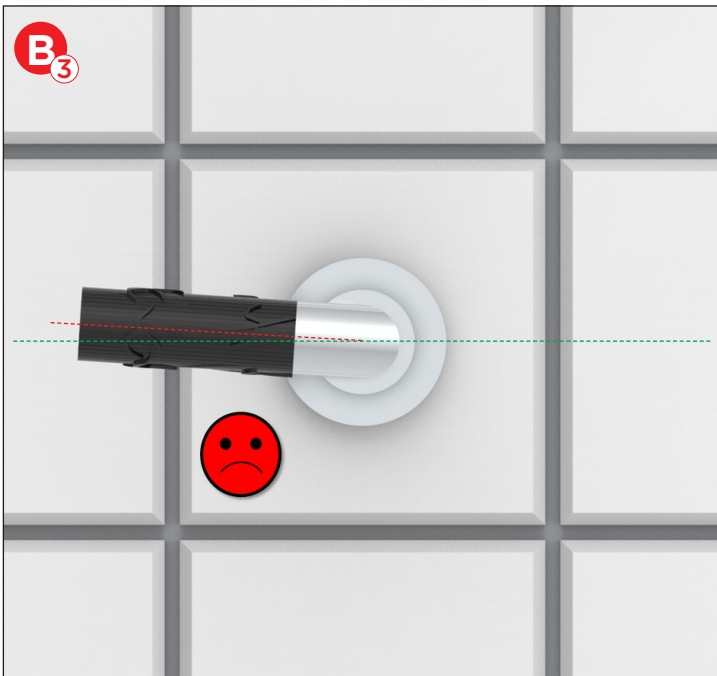
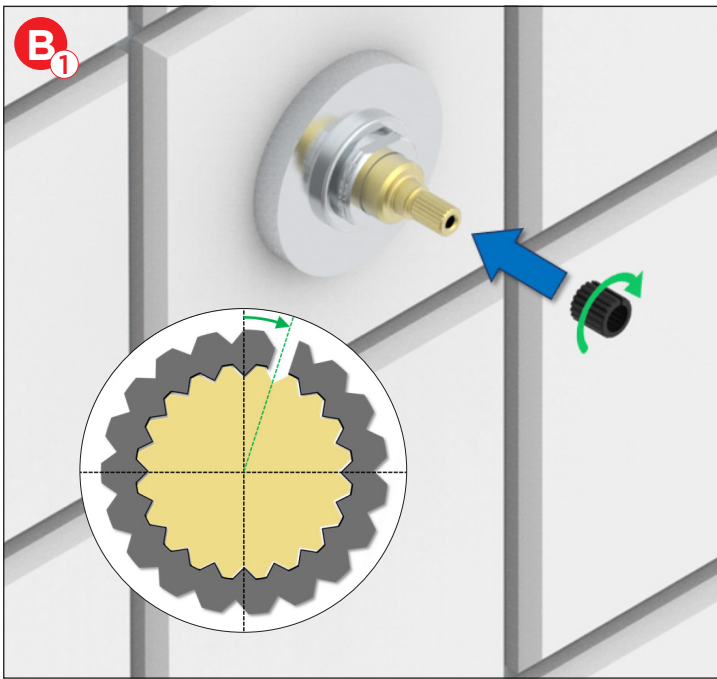

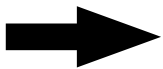
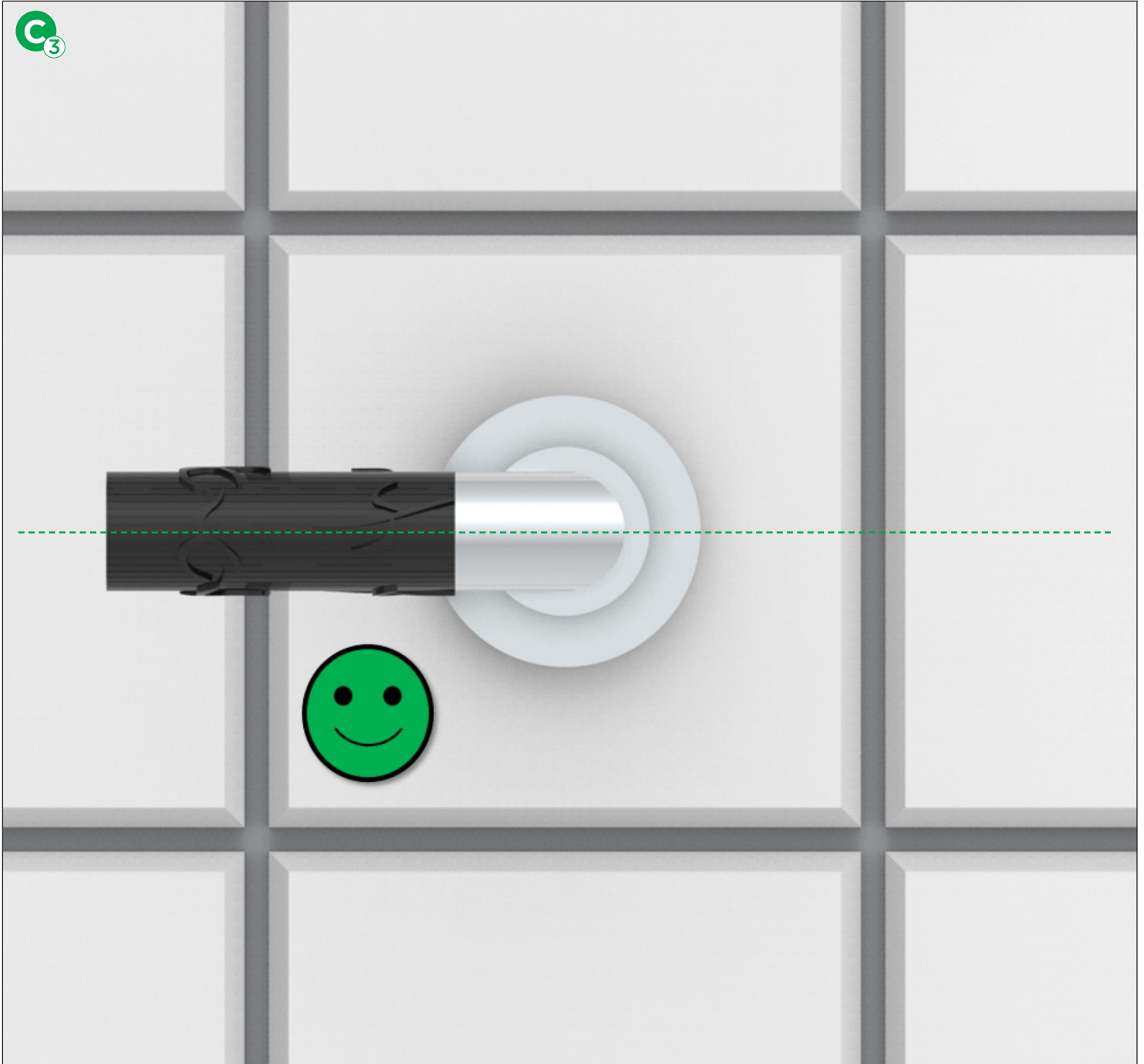

**Répéter l'opération jusqu'à obtenir la position verticale ou horizontale (19 positions possibles)**

*Repeat the procedure until you obtain the right vertical or horizontal position (19 possible positions)*

重复操作，直达到垂直或水平位置（可能有 19 个位置）

Wiederholen Sie den Vorgang, bis die vertikale oder horizontale Position erreicht ist (19 mögliche Positionen)

Repetir la operación hasta obtener la posición vertical u horizontal (19 posiciones posibles)

Ripetere l'operazione fino al raggiungimento della posizione verticale o orizzontale (sono possibili 19 posizioni)

Herhaal de handling totdat u de verticale of horizontale positie bereikt (19 mogelijke posities)

Повторяйте операцию, пока не достигнете вертикального или горизонтального положения (возможны 19 положений)

كرر العملية إلى غاية الحصول على الوضع العمودي أو الأفقي (٩١ وضعاً ممكناً)