



# Shower System S-4401 Installation Brief

## Model Number

S-4401 Shower System

## Decorative Finish Code

append to part numbers if applicable

- STN Satin Nickel
- Chrome (standard)

## Tools & Materials

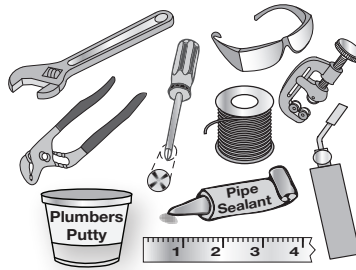

## Need Help?

Contact Symmons customer service at (800) 796-6667, (781) 848-2250, customerservice@symmons.com Mon - Fri 7:30 am - 7:00 pm EST

Please check Symmons website for technical help, the latest product information and warranty policy. [www.symmons.com/service](http://www.symmons.com/service)

## Rough-in Installation

### Control valve, piping & fittings

Reference rough-in dimension illustration on page 2 as required.

#### 1) Determine wall thickness

- Determine type of wall and wall thickness where valve will be mounted.
- Consider whether to use mounting plate by reviewing figure 2 below.
- Skip ahead to **Step 3** if mounting plate will not be used.

#### 2) Attach mounting plate to valve

Seat mounting plate against valve assembly as illustrated in figure 1.

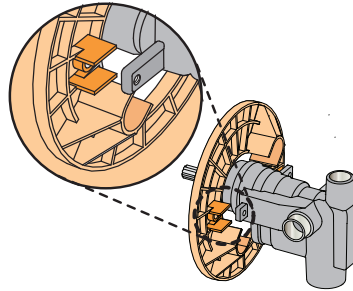

Figure 1 Mounting plate

#### 3) Attach protective shield

- Reference figure 2 to determine whether shield is required.
- Attach plastic protective shield by snap fitting over end of valve spindle.

#### 4) Install piping, fittings and control valve

*Piping and fittings not supplied*

##### ▪ Control Valve

Install valve through cutout hole in wall as specified in figure 2 below and dimension illustration on page 2.

##### ▪ Showerhead (S on valve)

Pipe from outlet port on valve marked **S** to showerhead mounting arm location.

##### ▪ Hot & Cold Supply (H & C)

Pipe hot water supply to valve input marked **H** and cold water supply to valve input marked **C**.

### Walls for using T-177 mounting plate

- Fiberglass or acrylic walls (required)
  - Plaster or other type walls (optional)
- 1/16" (2 mm) min ▪ 1/2" (13 mm) max

#### Protective shield

When mounting plate is used, then shield is optional for protecting end of valve during installation.

"snap on-off"

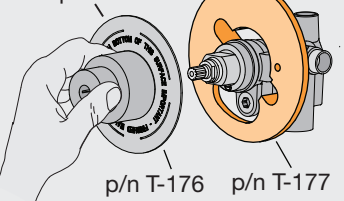

p/n T-176

p/n T-177

wall cutout hole size  
3-1/2" (95 mm) min  
4" (101 mm) max

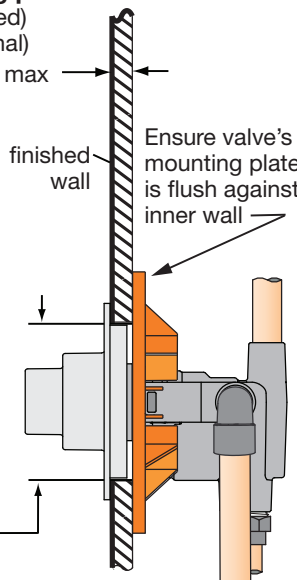

### Dry wall, plaster or other type wall

1/2" (13 mm) or greater finished wall

2" ± 1/2"  
(51 mm ± 13 mm)  
pipe centerline  
to finished wall

Finished wall must be flush with back side of protective shield surface

Protective shield "snap on-off" (required when mounting plate is not used)

wall cutout hole size  
3-1/2" (89 mm) min  
4" (101 mm) max

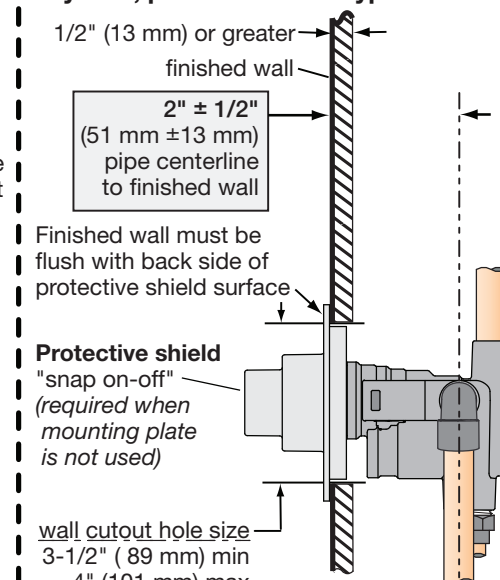

Figure 2 Mounting valve

**5) Remove protective shield**

If attached in **Step 3**, then remove shield snap fitted over the end of valve spindle once valve is securely installed and wall finish work has been completed.

**6) Adjust valve packing nut**

Reference figure 3

- Turn hot & cold supplies on. Valve will not operate unless both hot and cold water supply pressures are on.
- Place handle over *control spindle stem*.
- Adjust *packing nut* for positive frictional resistance as handle is rotated from shutoff position across adjustment range.

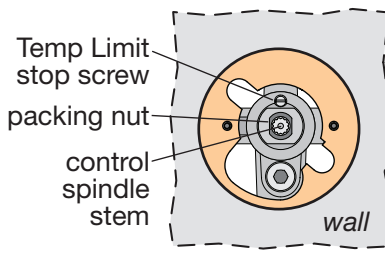

Figure 3 Valve adjustments

**7) Flush system and check for leaks**

- Turn valve to the warm position and run for a few minutes.
- If system is dirty, remove valve spindle in center of valve to ensure proper flushing. (See service instructions.)
- Check for leaks around valve assembly and all pipe fittings.

**8) Set Temp Limit stop screw**

Reference figure 3

The limit stop screw limits valve handle from being turned to maximum position resulting in excessive hot water discharge temperatures.



**Warning:** Failure to adjust *limit stop screw* properly may result in serious scalding.

- Place handle on control spindle and open valve to maximum desired temperature.
- Turn limit stop screw clockwise until it seats.

**Note:** Do not install positive shut-off devices on control valve outlet or devices that do not allow the valve to flow at least 1.5 gpm.

**Dimensions Carrington Shower System, S-4401**

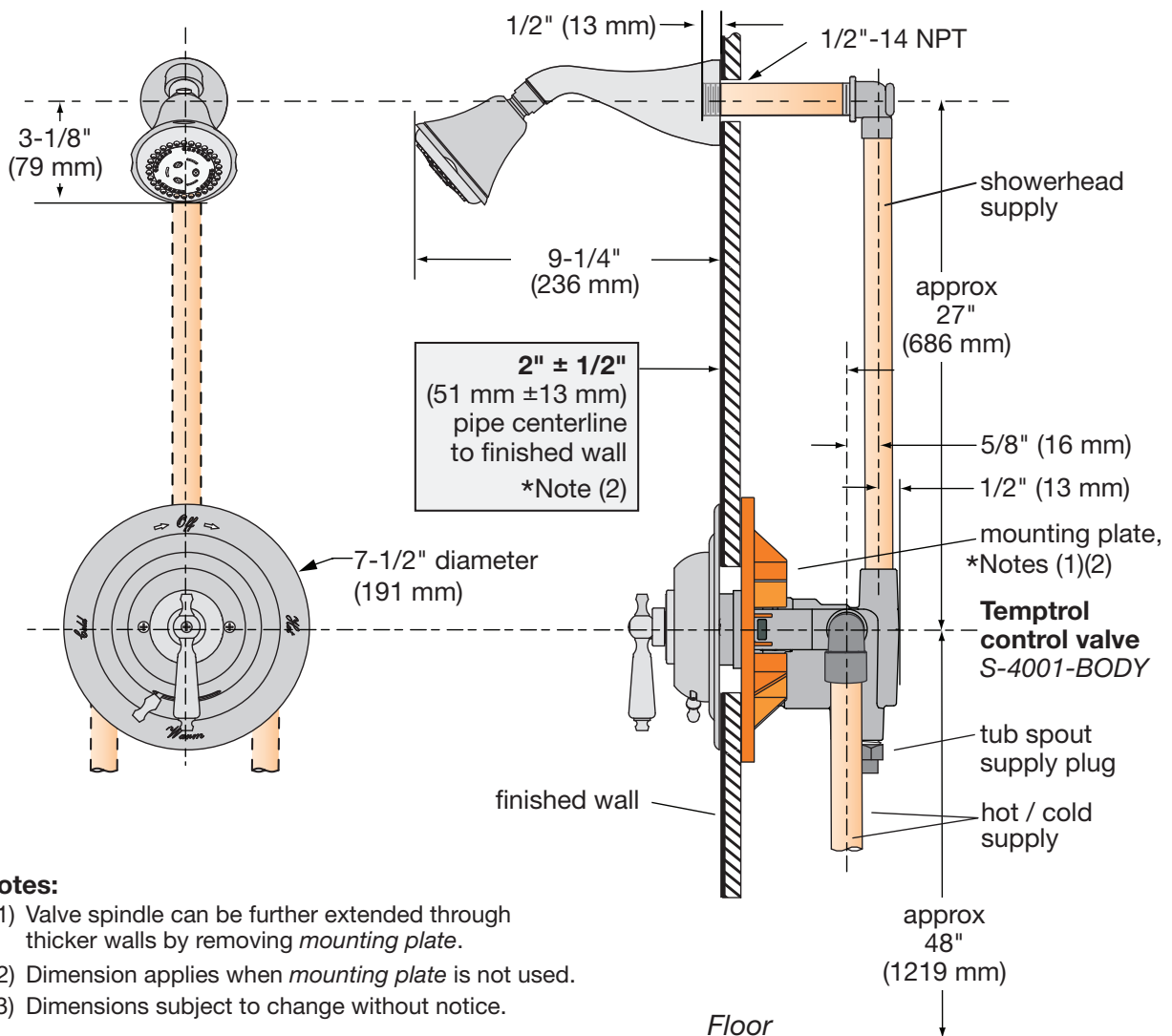

**\*Notes:**

- (1) Valve spindle can be further extended through thicker walls by removing *mounting plate*.
- (2) Dimension applies when *mounting plate* is not used.
- (3) Dimensions subject to change without notice.

# Parts Assembly *Temptrol Shower Control Valve, S-4001-BODY*

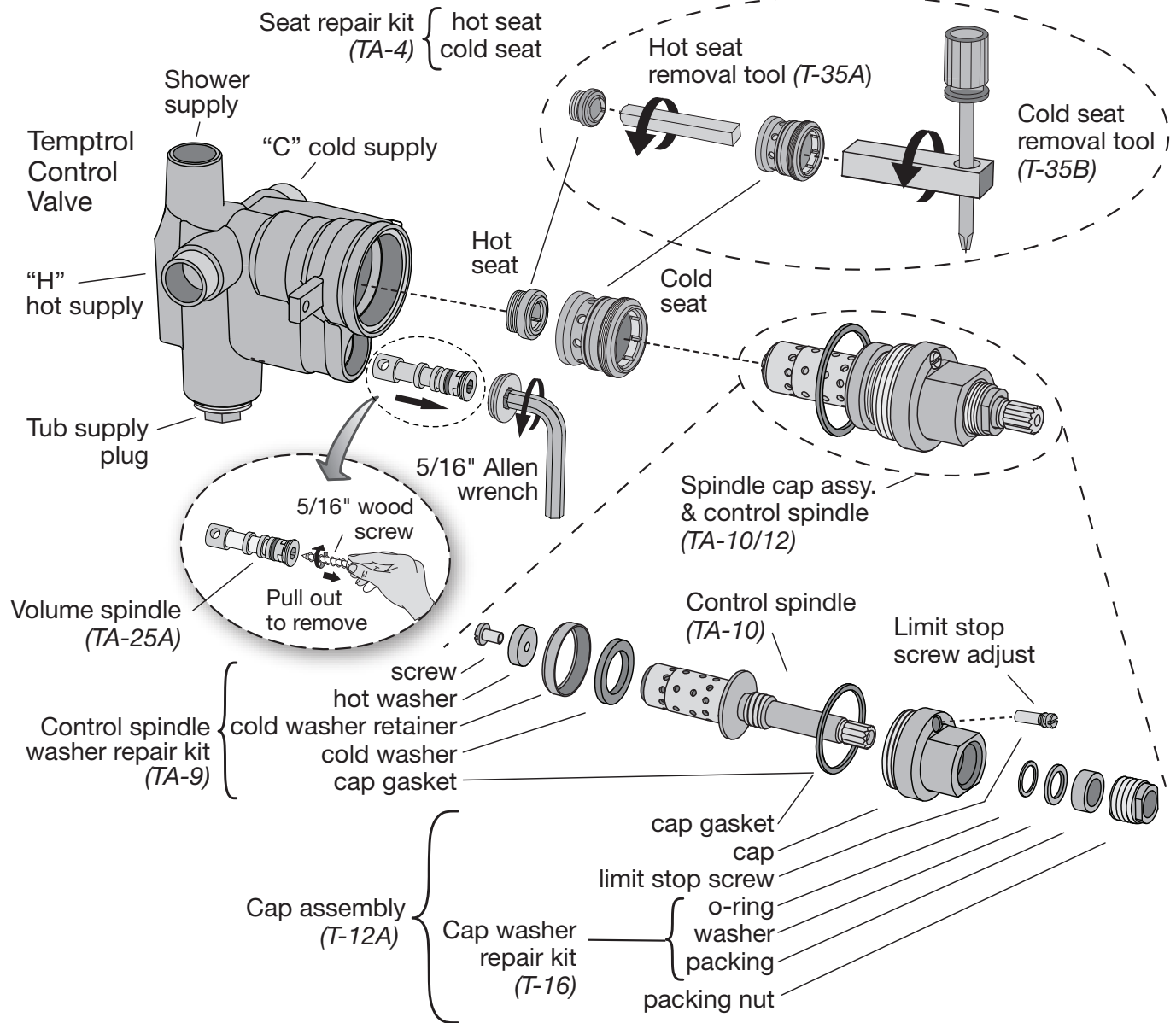

## Replacement Parts and Special Tools

Part Number	Description
TA-4	Hot and cold seat repair kit (requires tools p/n T-35A and T-35B)
TA-9	Control spindle washer repair kit
TA-10	Control spindle (includes TA-9-RP Repair kit)
T-12A	Cap assembly
T-16	Cap washer repair kit
TA-25A	Volume spindle kit
T-35A	Hot seat removal tools
T-35B	Cold seat removal tools
T-108	Reverse seat and tool kit (valve hot and cold supply inputs are reversed)

## Trouble Shooting Chart

Problem	Cause	Solution
Valve will not pass water.	Both hot and cold water supplies are not turned on.	Turn on both supplies. Valve will not operate unless both hot and cold water pressure is on.
Valve leaks when shut off.	Hot and cold washers are worn or foreign matter (dirt, chips) is lodged between washers and seat surfaces.	1) Replace washers using <i>control spindle washer repair kit</i> , p/n TA-9. 2) Replace hot & cold seats using <i>hot/cold seat repair kit</i> , p/n TA-4.
Temperature control handle is turned from cold to hot (or hot back to cold) and volume from spout or head is not constant.	Pressure-balancing piston housed in spindle assembly is restricted from free movement by foreign matter.	1) Open valve halfway, remove handle and tap spindle with plastic hammer. 2) Check <i>water pressure balancing piston</i> in <i>control spindle</i> . See service instructions. 3) Replace <i>control spindle</i> , p/n TA-10.
Valve delivers sufficient quantity of cold, but little hot, or the reverse.	Same as above	Same as above
Temperature varies without moving handle.	Same as above	Same as above
Valve delivery temperature reduces gradually during use; handle must be turned to hotter positions to maintain constant temperature.	Overdraw on hot water supply (i.e. running out of hot water).	Reduce maximum flow by using volume control adjustment on valve or showerhead. This will allow longer period of use before overdrawing hot water supply.
Valve delivers hot water when initially opened. Water turns colder as handle is rotated in a counter-clockwise direction toward the hot position.	Valve is piped incorrectly (i.e. the hot supply is piped to the valve's cold inlet and the cold supply is piped to the hot inlet.)	If piping is accessible, correct connections to the valve. If piping is not accessible, order a <i>reverse seat and tool kit</i> , p/n T-108. Older installations may also require replacing the hot seat, <i>hot/cold seat repair kit</i> , p/n TA-4.

### Service Instructions

#### Removing control spindle assembly

(Ref. *parts assembly figure*)

- Shut off water supply to valve and remove control valve handle and dome cover.
- Remove escutcheon plate by first removing escutcheon screws.
- Turn valve's *control spindle* to half way position between minimum and maximum rotation.



**Important:** Failure to do this can damage *control spindle assembly*.

- Unscrew both *spindle cap* and *control spindle assembly*.

#### Hot/Cold seat repair kit

Order p/n TA-4, T-35A and T-35B.

Installation requires both hot & cold removal tools, p/n T-35A & T-35B.

- Remove *control spindle assembly*.
- Remove both seats with removal tools.

- Replace both seats even if only one appears worn.
- Install and tighten both seats to 15 foot pounds of torque.

#### Control spindle washer repair kit

Order p/n TA-9.

- Remove *control spindle assembly*.
- Remove *cold washer* by holding spindle using valve handle and unscrew *cold washer retainer* using channel lock pliers.
- Remove *hot washer* by removing *hot washer screw*.

#### Checking water pressure balancing piston

The perforated end of the *control spindle assembly* houses the water pressure-balancing piston which is the heart of the valve.

- Remove *control spindle assembly*.
- Shake spindle assembly and listen for clicking noise. Piston should be free to slide back and forth the full length of its travel.

- If piston appears restricted then do the following:
  - (1) Tap the handle or stem end of the spindle against a solid object to free the piston.
  - (2) Try soaking in household vinegar and repeat step (1).
- If unable to free piston, replace *control spindle*, p/n TA-10.



**Important:** Do not attempt removal of the piston.

#### Valve re-assembly

Reassemble by reversing above procedures.

After the *control spindle assembly* (TA-10) is threaded back into the spindle cap assembly (T-12A) ensure *control spindle* is rotated 1/2 turn clockwise from its maximum counter clockwise rotational position. Failure to do this will damage assembly.