

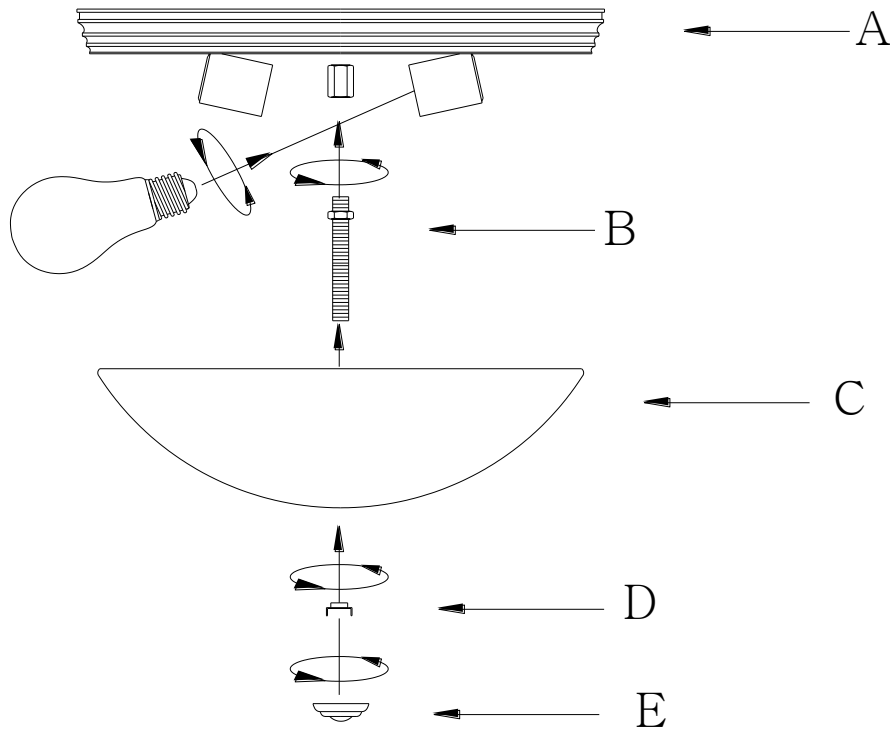

ASSEMBLY INSTRUCTIONS
ITEM NO.: 6-780-13-13&6-781-13-13
&6-780-13-SN&6-780-13-109



B → A → C → D → E

1. Carefully unpack and identify all parts referring to the illustration for parts identification.
2. Turn power to the installation point **OFF**.
3. Referring to the installation instruction with the product for the wiring and installation.(Use the coupling instead of the finial)
4. Install proper bulbs (not provided) to sockets referring to the markings and/or labels on the fixture for maximum wattage.
5. Thread the top end of nipple (B) into the coupling under the center of fixture body (A). Hand tighten until snug.
6. Carefully pass the glass shade (C) into position though the nipple (B) and thread by the nut (D) for extra secure, then tighten the finial (E) to cover the bottom.
7. Restore power to the installation point **ON**. Retain this sheet for future reference.