

MTSB-6030Seated

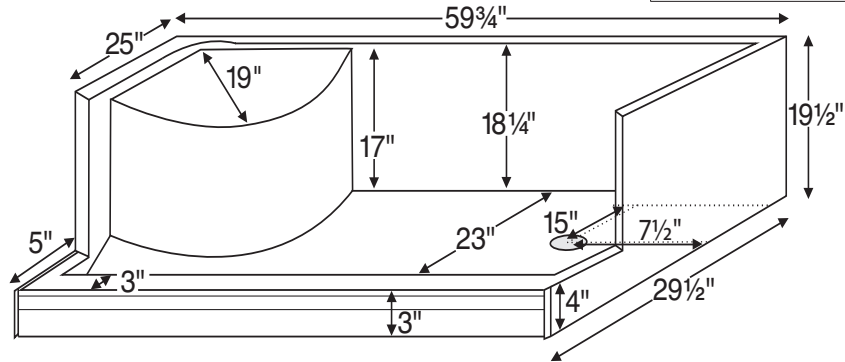

Shown above with right-hand drain.

59.75" x 29.5" x 19.5" (exterior bottom of base)
LOW-PROFILE, SEATED THRESHOLD textured floor
End Drain
Acrylic CXL®
100 lbs / 45 kg



When ordering, please specify left- or right-hand drain.

Model #	Size	Shape	MSRP
SB6030Seated	59.75" x 29.5" x 19.5"	Rectangle	\$2,070

Options <i>Must be ordered at time of purchase</i>
Color Please specify color on order White (CWH) Biscuit (CBS)
Quick Ship (QSPRI) \$430 Reduces lead time. Please call for availability.
Radiance® (RAD100) \$1,595 Shower floor heating system. Radiance heating grids are fully integrated within the acrylic shell structure of the shower floor. Requires a 110-volt, 15 amp GFCI and remote installation of control box & keypad.
Pre-Levelled Foam Base (PLFSB) \$220
PVC Drain Kit Finishes Chrome included with shower base Brushed Nickel upcharge (SBDKBN) \$65

Accessories
Drain Kit Options Solid Brass Drain Kit with Stainless Steel Cover (SBDKSB) \$195
Teak Bath Mat (TKMAT3018) \$815 Measures 30" x 17.5" x 1" Custom sizes also available. Contact MTI for details.
Teak Shower Tray (TK6030SEATED) Contact MTI for pricing

IMPORTANT ORDERING & INSTALLATION INFORMATION

- Single, front threshold design with integrated seat.
- 3-sided integral tile flange to facilitate installation. Must specify drain hand on order.
- 3.5" drain opening pre-drilled.
- Drain finish options on this sheet are upcharge prices only. Contact MTI for ordering details for drain kits sold separately.
- Compliant with ASTM C 1028-07 coefficient of friction test.
- Add proper wet-bedding compound to fully support bottom of shower base. Optional factory installed Pre-Levelled Foam Base negates the need to wet bed when installing on a flat, level subfloor. See installation instructions.

• Options and accessories may be packaged inside the box. Always check packaging before discarding.
• All product measurements are ±1/2".
• Specifications and configurations are subject to change without notice.
• Measurements herein supersede all others published prior to publication date below.

See the Installation & Operation Manual for more details.
MTI's Customer Service: Monday-Friday 8am-6pm EST
800-783-8827 or service@mtibaths.com

CSA # MTSB-6030SEATED

©2023 by MTI Baths, Inc. Modification Rights Reserved

