

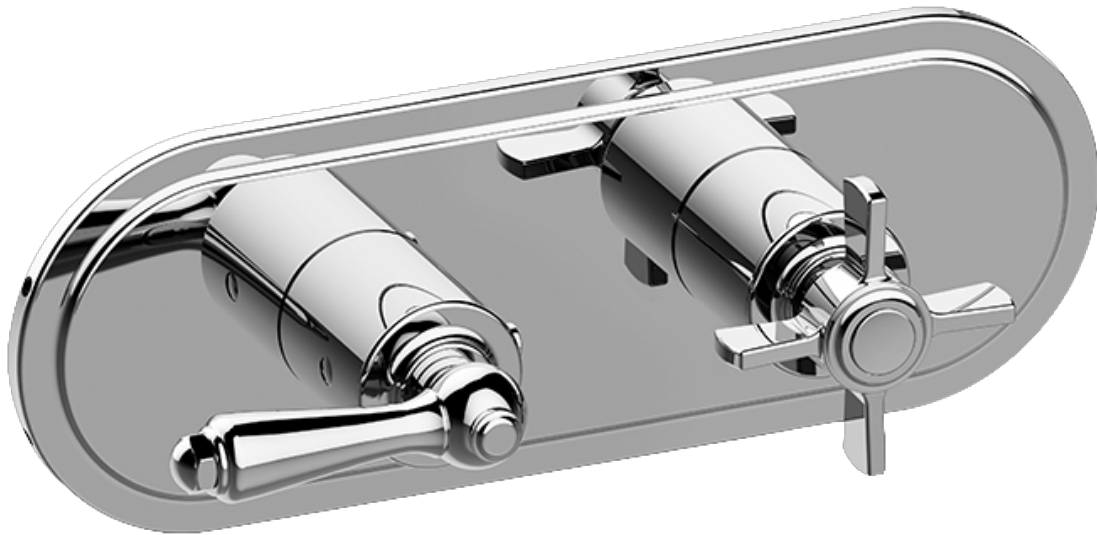













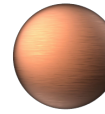

SHOWER
M-Series Valve Horizontal Trim
with Two Handles
G-8086H-LM48C16-T



Information

- Two metal handles, decorative trim plate
- Use with M-Series rough valves
- LM48E0 handles should not be used with 2-way or 3-way diverter valves
- ADA

Finishes

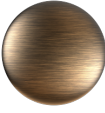
							
24K Gold	24K Brushed Gold	Brushed Brass PVD	Architectural Black™	Brushed Nickel	Brushed Onyx PVD®	Brushed OR'osa PVD®	Gunmetal
							
Matte Black	Olive Bronze	Onyx PVD®	Polished Brass PVD	Polished Chrome	Polished Nickel	OR'osa PVD®	Unfinished Brass
							
Unfinished Brushed Brass	Vintage Brushed Brass	Architectural White					