

 satin finish

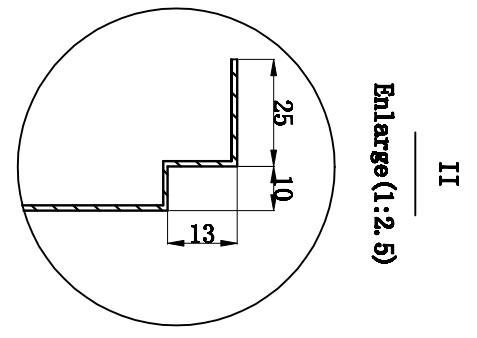
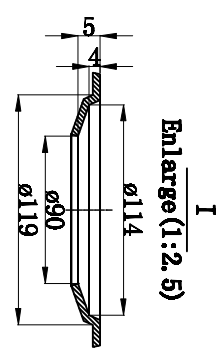
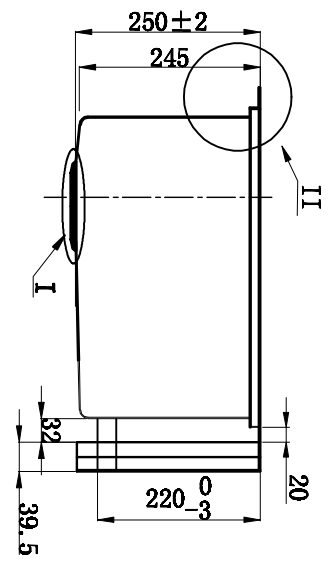
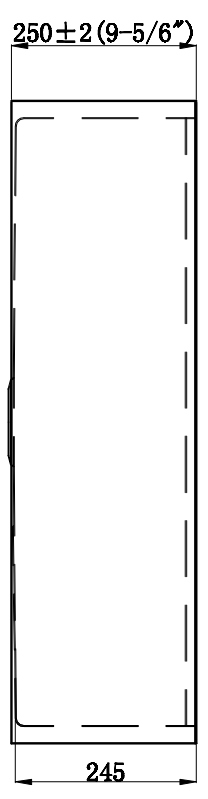
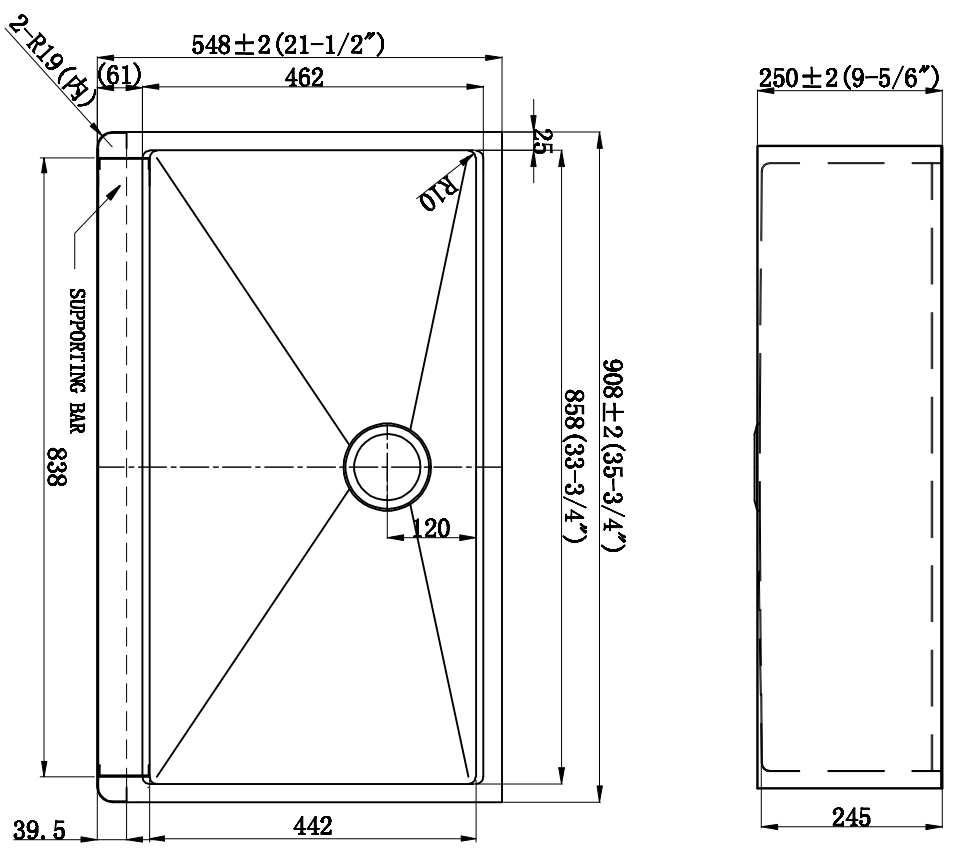

A36S
material&thickness SUS304 16GA
EMPIRE INDUSTRIES INC.