

Model# 0128-A

Two Handle Cast Brass Kitchen Faucet

FEATURES & SPECIFICATIONS

- Canopy Handles
- 8" D Style Swivel Spout
- Replaceable Seats
- 4-Hole 6" Installation
- Side Spray Assembly 1.5 GPM Flow Rate
- 1.5 GPM Flow Rate

FINISHES

- PC Polished Chrome

STANDARDS

- ASME A112.18.1
- ANSI / NSF 61, SECTION 9
- CUPC / IAPMO LISTED
- ANSI A117.1 / ADA COMPLIANT
- CONTAINS NO MORE THAN 0.25% WEIGHTED AVERAGE LEAD CONTENT



FLOW

- 1.5 GPM Flow Rate

WARRANTY

- Lifetime Limited Warranty
- Lifetime Residential Warranty
- 5 Year Commercial Warranty

0128-A/REV. 11 2016

Product Specifications subject to change without notice

Job Name _____ Date _____
Model Specified _____ QTY _____
Customer/Wholesaler _____
Contractor _____
Architect/Engineer _____
Submitted as Shown _____
Submitted w/ Variations _____

Model# 0128-A

Two Handle Cast Brass Kitchen Faucet

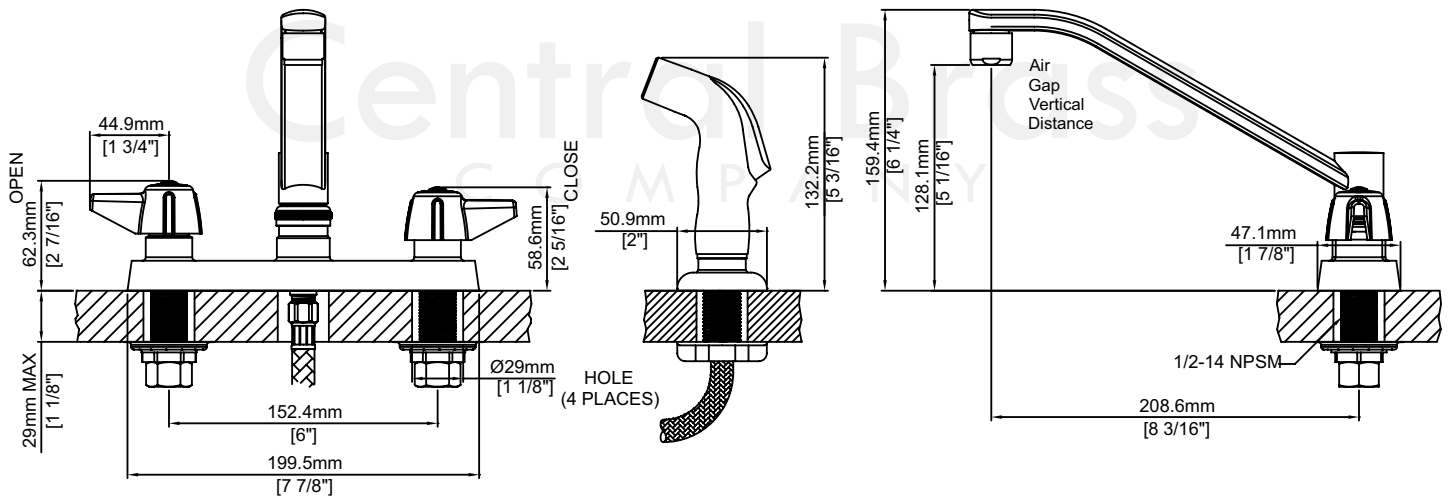

0128-A/REV. 11 2016

Product Specifications subject to change without notice