

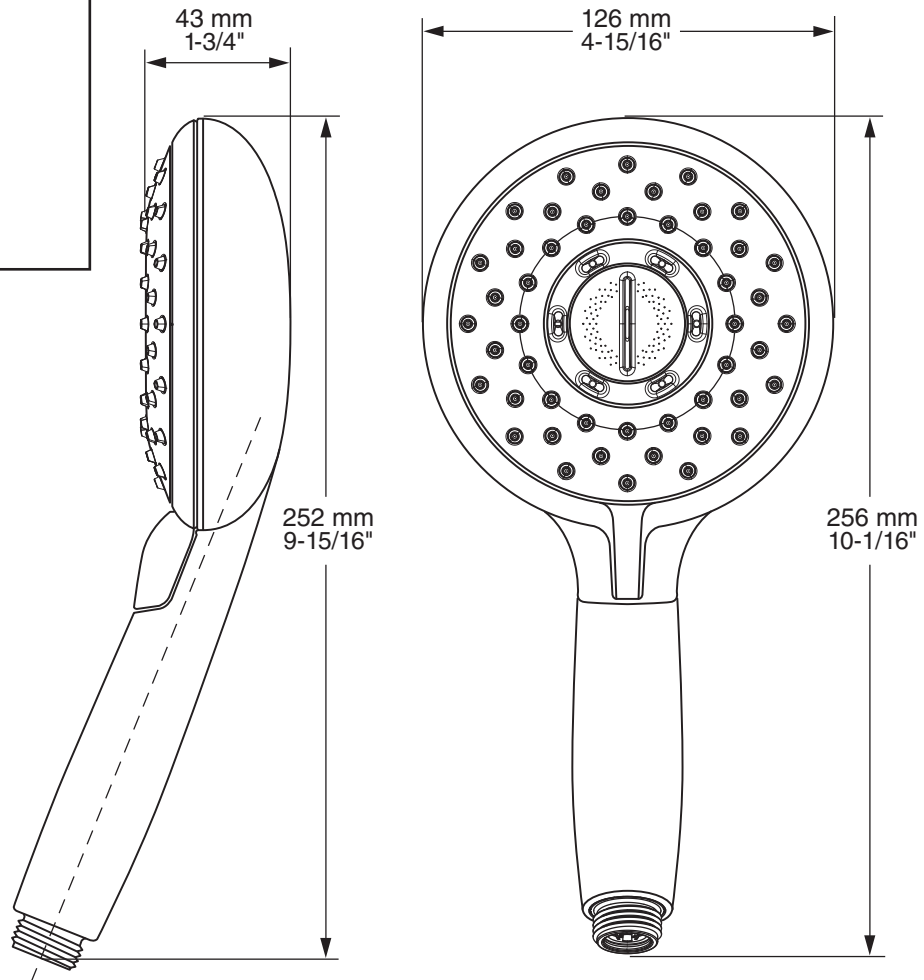

**MODEL NUMBER:**

□ 9038.154 Spectra+™ 4-Function Hand Shower



**GENERAL DESCRIPTION:**

5" (127 mm) Hand shower adjusts from Drench to Sensitive to Powerwash® to Massage. Permanent built-in compensating flow control device. 1.8 gpm/6.8 L/min. maximum flow rate.

**PRODUCT FEATURES:**

**Water Saving:** WaterSense certified.

**Pressure Compensating Flow Control Device:** Provides consistent flow over a wide pressure range.

**Variety of Spray Functions:** Allows the user to select the spray functions best suited to their needs.

**SUGGESTED SPECIFICATION**

Hand shower shall have 4 spray functions. Hand shower shall have a pressure compensating flow control device. Hand shower shall include check valve to prevent cross flow of hot and cold water. Fitting shall be American Standard Model # 9038.154.\_\_\_\_.





**CODES AND STANDARDS**

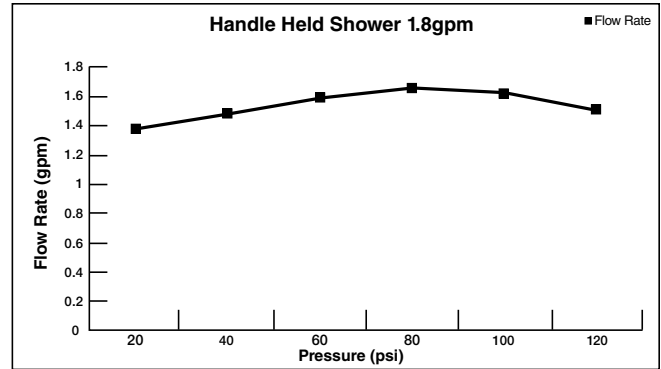

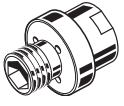

These products meet or exceed the following codes and standards:

- ASME A112.18.1**
- CSA B125.1**
- EPA WaterSense**



Product Number	Description	Finish Options			
		Polished Chrome	Brushed Nickel	Polished Nickel (PVD)	Legacy Bronze
		002	295	013	278
9038.154	Spectra+™ 4-Function Hand Shower. 1.8 gpm Max Flow.				

Hand Shower Accessories	
Product Number	Description
8888.035	59" Metal Shower Hose 
8888.053	79" Metal Shower Hose (Chrome Only) 
1660.400	Vacuum Breaker 
1660.410	Shower Arm Diverter 
8888.096	Shower Arm Bracket 

Hand Shower Accessories	
Product Number	Description
8888.036	Fixed Wall Bracket 
8888.037	Wall Supply 
8888.068	Round Wall Supply 
8888.069	Square Wall Supply 
8888.038	Wall Supply Bracket 